

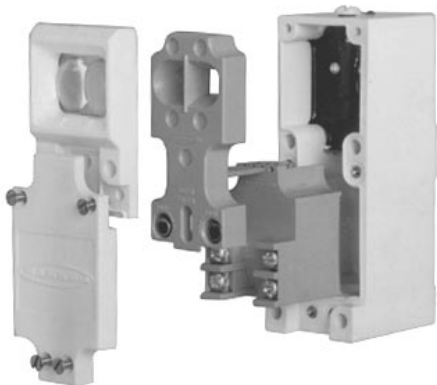

MULTI-BEAM[®] Sensors

Compact modular self-contained photoelectric sensing controls

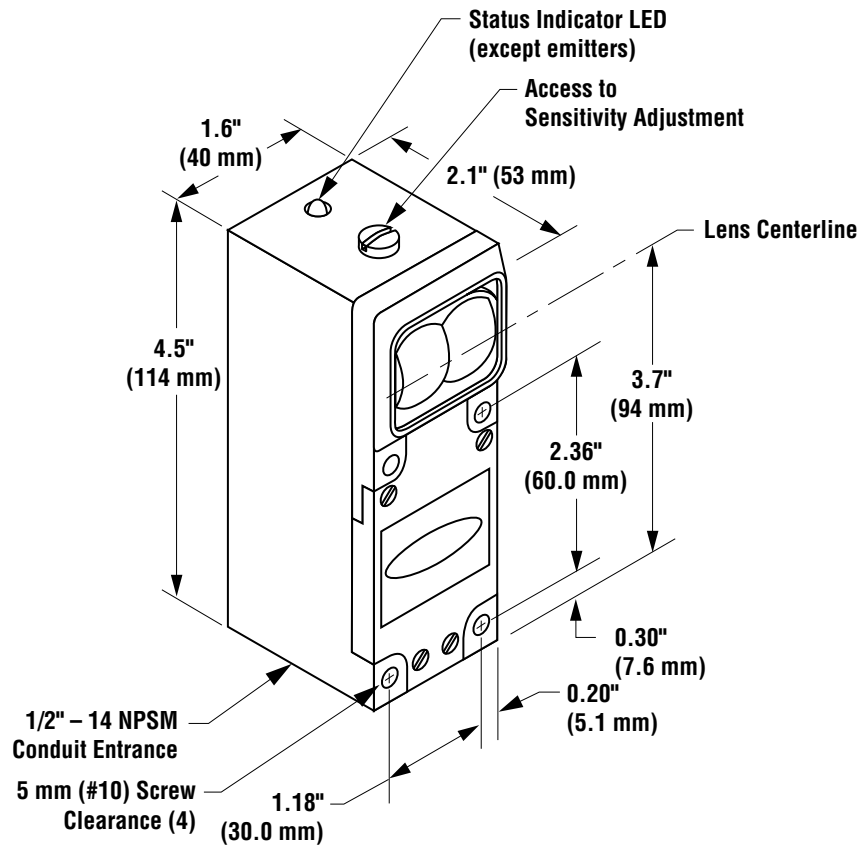

- Modular design with interchangeable components (scanner blocks, power blocks, and logic timing modules); over 5,000 sensor configurations possible
- *Scanner blocks* for opposed, retro, diffuse, convergent, and fiber optic sensing modes (including high-gain models)
- *Power blocks* for ac or dc operation, including 2-wire ac operation
- *Logic modules* to support a wide variety of delay, pulse, limit, and rate sensing logic functions
- Most scanner blocks include Banner's exclusive, patented AID™ (Alignment Indicating Device) system, which lights a top-mounted indicator LED whenever the sensor sees its own modulated light source, and pulses the LED at a rate proportional to the strength of the received light signal.

MULTI-BEAM[®] Sensors

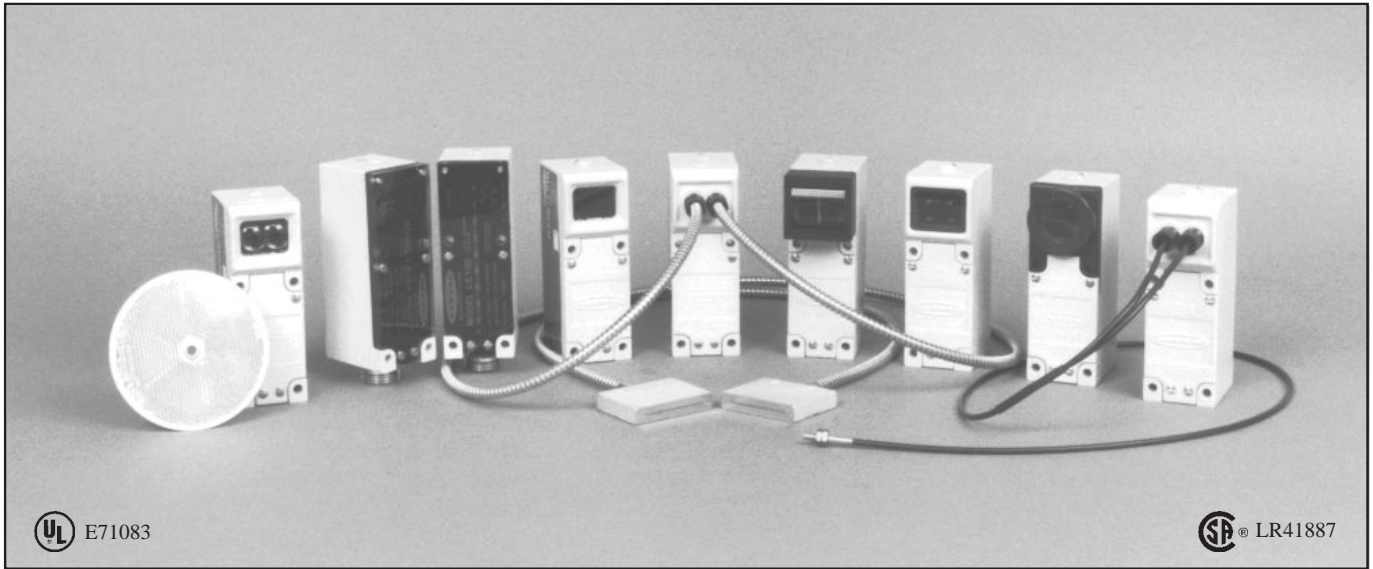

UL E71083

SP[®] LR41887

Banner MULTI-BEAM[®] sensors are compact *modular* self contained photoelectric switches. Each MULTI-BEAM consists of three components: scanner block, power block, and logic module. The *scanner block* contains the complete modulated photoelectric amplifier as well as the emitter and receiver optoelements. It also contains the sensing optics and the housing for the other two modules. The *power block* provides the interface between the scanner block and the external circuit. It contains a power supply for the MULTI-BEAM plus a switching device to interface the circuit to be controlled. The *logic module* interconnects the power block and scanner block both electrically and mechanically. It provides the desired timing logic function (if any), plus the ability to program the output for either light- or dark-operate. The emitters of MULTI-BEAM emitter-receiver pairs do not require a logic module. Emitter scanner blocks are supplied with a blade-pin to interconnect the scanner block and power block. This modular design, with field-replaceable power block and logic module, permits over 5,000 sensor configurations, resulting in exactly the right sensor for any photoelectric application.

There are two families of MULTI-BEAM sensors: 3- and 4-wire, and 2-wire. Three- and four-wire MULTI-BEAMS offer the greatest selection of sensor configurations. They permit either ac or dc operation and offer the fastest response times and the greatest sensing ranges. Two-wire MULTI-BEAMS are used in ac-powered applications where simplicity and convenience of wiring are important. They are physically *and* electrically interchangeable with heavy-duty limit switches.

The circuitry of all MULTI-BEAM components is encapsulated within rugged, corrosion-resistant VALOX[®] housings, which meet or exceed NEMA 1, 3, 12, and 13 ratings. Most MULTI-BEAM scanner blocks include Banner's patented Alignment Indicating Device (AID[™]) which lights a top-mounted LED when the sensor sees its own modulated light source and pulses the LED at a rate proportional to the received light signal. Most MULTI-BEAM sensor assemblies are UL listed and certified by CSA (see power block listings). All MULTI-BEAM components (except power block models 2PBR and 2PBR2) are totally solid-state for unlimited life.

Composite Functional Schematic, 3- and 4-wire Sensors

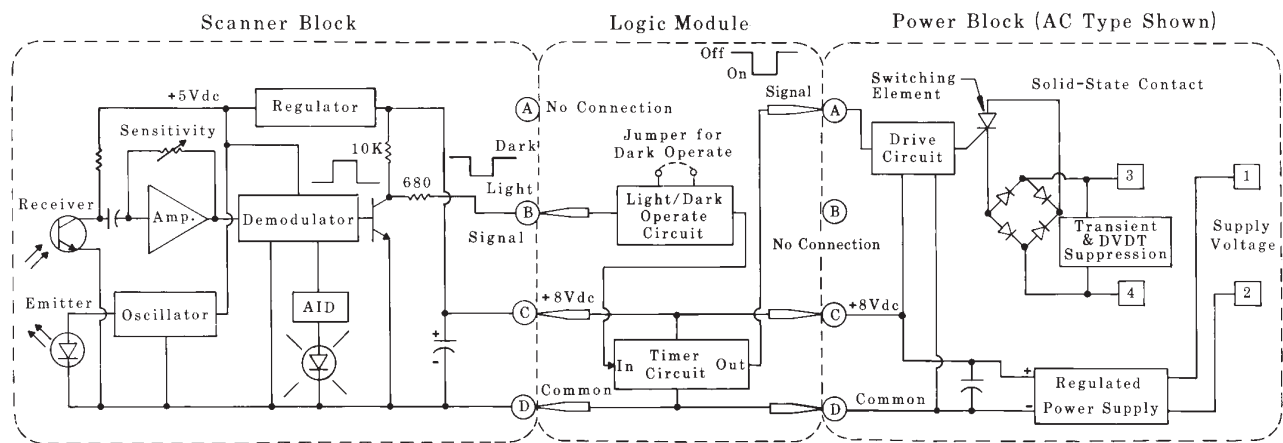

Selection of MULTI-BEAM Components

MULTI-BEAM sensors are made up of three components: scanner block, power block, and logic module. This is true for all MULTI-BEAMs with the exception of opposed mode emitter units which require only a power block (no logic module).

The first decision in the component selection process is to determine which family of MULTI-BEAM sensors is appropriate for the application: 3- and 4-wire, or 2-wire.

Next, decide which scanner block (within the selected family) is best for the application. The guidelines in the catalog introduction will help you to determine the best sensing mode. Then narrow the choice by comparing the specifications listed in the following charts and on the pages referenced in the charts.

Finally, choose a power block and logic module to complete the MULTI-BEAM assembly. Components snap together without inter-wiring to form a complete photoelectric sensing system that meets your exact requirements while maintaining the simplicity of a self-contained sensor.

If you have any questions about selecting MULTI-BEAM components, please contact your Banner sales engineer or call Banner's Applications Department at (612) 544-3164 during normal business hours.

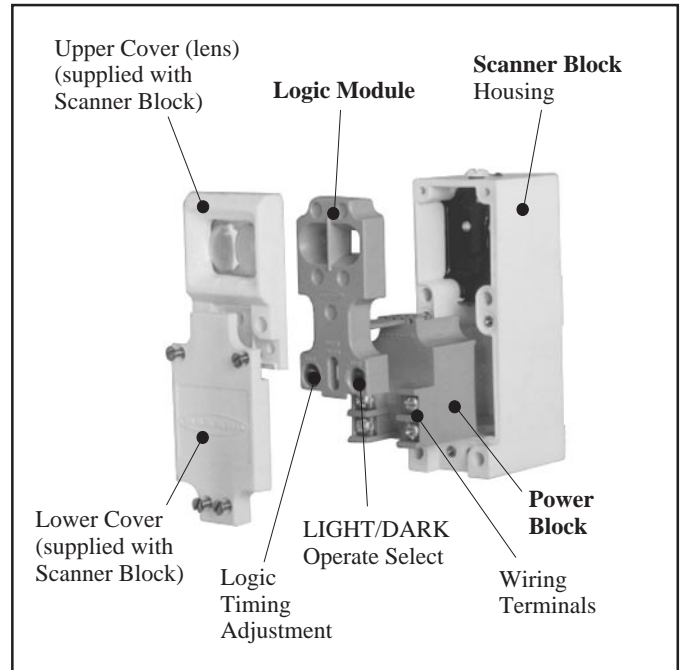

3- and 4-wire Systems (pages 6 through 23)

Scanner Blocks	Model	Sensing Mode	Range	Response	Page
	SBE & SBR1	Opposed: high speed	150 feet	1 millisecond	p. 7
	SBED & SBRD1	Opposed: high speed, narrow beam	10 feet	1 millisecond	p. 7
	SBEX & SBRX1	Opposed: high power, long range	700 feet	10 milliseconds	p. 7
	SBEV & SBRV1	Opposed: visible beam	100 feet	10 milliseconds	p. 7
	SBEXD & SBRXD1	Opposed: high power, wide beam angle	30 feet	10 milliseconds	p. 7
	SBLV1	Retroreflective: high speed, visible beam	30 feet	1 millisecond	p. 8
	SBLVAG1	Retroreflective: polarized beam (anti-glare)	15 feet	1 millisecond	p. 8
	SBL1	Retroreflective: high speed, infrared beam	30 feet	1 millisecond	p. 8
	SBLX1	Retroreflective: high power, long range	100 feet	10 milliseconds	p. 8
	SBD1	Diffuse (proximity): high speed	12 inches	1 millisecond	p. 9
SBDL1	Diffuse (proximity): medium range	24 inches	1 millisecond	p. 9	
SBDX1	Diffuse (proximity): high power, long range	6 feet	10 milliseconds	p. 9	
SBDX1MD	Diffuse (proximity): wide beam angle	24 inches	10 milliseconds	p. 9	
SBCV1	Convergent beam: high speed, visible red	1.5-inch focus	1 millisecond	p. 10	
SBCVG1	Convergent beam: high speed, visible green	1.5-inch focus	1 millisecond	p. 10	
SBC1	Convergent beam: high speed, infrared	1.5-inch focus	1 millisecond	p. 10	
SBC1-4	Convergent beam: high speed, infrared	4-inch focus	1 millisecond	p. 10	
SBC1-6	Convergent beam: high speed, infrared	6-inch focus	1 millisecond	p. 10	
SBCX1	Convergent beam: high power, infrared	1.5-inch focus	10 milliseconds	p. 10	
SBCX1-4	Convergent beam: high power, infrared	4-inch focus	10 milliseconds	p. 10	
SBCX1-6	Convergent beam: high power, infrared	6-inch focus	10 milliseconds	p. 10	
SBEF & SBRF1	Opposed fiber optic (glass fibers): high speed	see specs	1 millisecond	p. 11	
SBEXF & SBRXF1	Opposed fiber optic (glass fibers): high power	see specs	10 milliseconds	p. 11	
SBFX1	Fiber optic (glass fibers): high power, infrared	see specs	10 milliseconds	p. 11	
SBF1	Fiber optic (glass fibers): high speed, infrared	see specs	1 millisecond	p. 12	
SBF1MHS	Fiber optic (glass fibers): very high speed	see specs	0.3 millisecond	p. 12	
SBFV1	Fiber optic (glass fibers): visible red	see specs	1 millisecond	p. 13	
SBFVG1	Fiber optic (glass fibers): visible green	see specs	1 millisecond	p. 13	
SBAR1	Ambient light receiver	see specs	10 milliseconds	p. 14	
SBAR1GH	Ambient light receiver: high gain	see specs	10 milliseconds	p. 14	
SBAR1GHF	Ambient light receiver: for glass fiber optics	see specs	10 milliseconds	p. 14	

MULTI-BEAM 3- & 4-WIRE SCANNER BLOCKS

DESCRIPTION

MULTI-BEAM 3- & 4-wire scanner blocks offer a complete complement of sensing modes. There are 3 or more models for each sensing mode, resulting in a choice of exactly the right sensor for any application. The high power models (10 millisecond response time) offer greater optical sensing power than any other industrial sensors.

SPECIFICATIONS

SUPPLY VOLTAGE: input power and output connections are made via a 3- or 4-wire power block (see pages 15 to 20).

RESPONSE TIME: 1 millisecond ON and OFF, except high gain models with "X" suffix and ambient light receivers which are 10 milliseconds ON and OFF.

REPEATABILITY OF RESPONSE: see individual sensor specs.

SENSITIVITY ADJUSTMENT: easily accessible, located on top of scanner block beneath o-ring gasketed screw cover. 15-turn clutched control (rotate clockwise to increase gain).

ALIGNMENT INDICATOR: red LED on top of scanner block. Banner's exclusive, patented Alignment Indicating Device (AID™) circuit lights the LED whenever the sensor detects its own modulated light source, and pulses the LED at a rate proportional to the received light level.

CONSTRUCTION: reinforced VALOX® housing with components totally encapsulated. Stainless steel hardware. Meets NEMA standards 1, 3, 12, and 13.

OPERATING TEMPERATURE RANGE: -40 to +70 degrees C (-40 to +158 degrees F).

VALOX® is a registered trademark of General Electric Company.

Functional Schematic, 3- and 4-wire Scanner Block

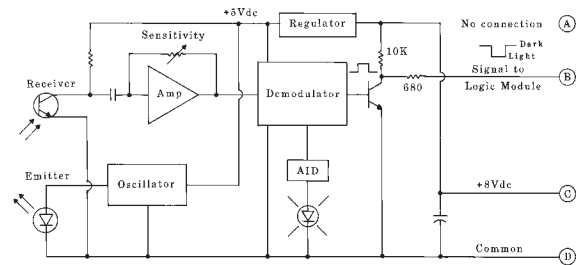

Dimensions, 3- and 4-wire Scanner Block

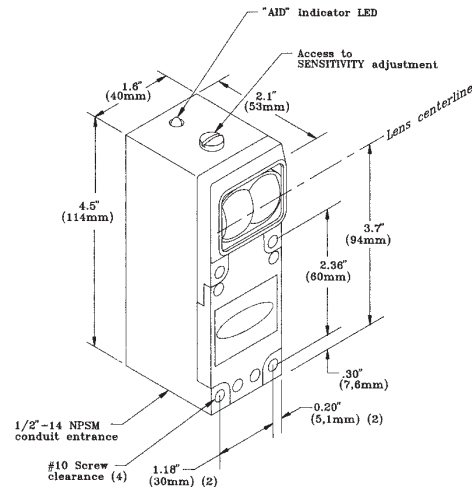

MULTI-BEAM 3- & 4-wire Scanner Blocks

Sensing Mode

Models

Excess Gain

Beam Pattern

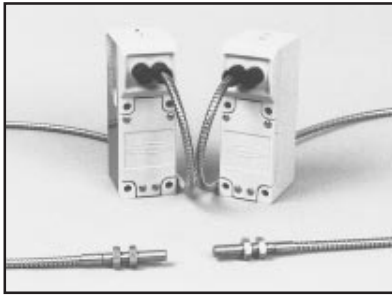

OPPOSED FIBER OPTIC Mode (glass fiber optics)

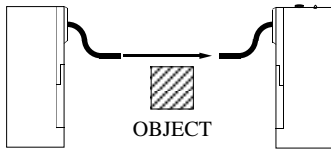

SBEF & SBRF1

Range: see excess gain curve
Response: 1ms on/off
Repeatability: 0.03ms
Beam: infrared, 880nm

NOTE: fiber optic gain curves apply to 3-foot fiber lengths. Gain decreases by approximately 10% for each additional foot of fiberoptic cable.

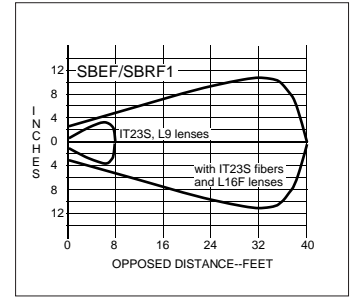
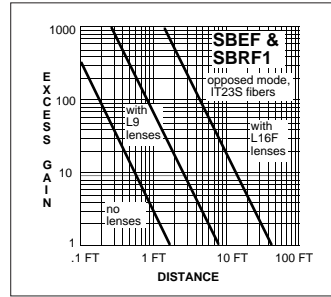

SBEF & SBRF1: use with individual glass fiber optic assemblies in lieu of model SBF1 where it is inconvenient to run fibers from a single scanner block.

SBEXF & SBRXF1: use in place of model SBFX1 (shown below) for long-range opposed fiber optic sensing. Or use where high excess gain is required and it is difficult to run the fibers to both sides of the process from a single scanner block. Lenses for fiber optics are shown in the Banner product catalog.

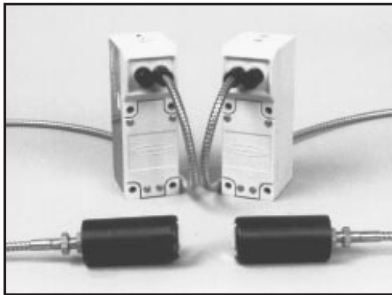

SBEXF & SBRXF1

Range: see excess gain curve
Response: 10ms on/off
Repeatability: 0.7ms
Beam: infrared, 880nm

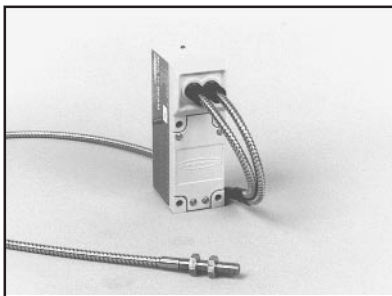
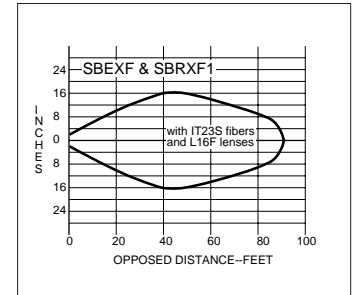
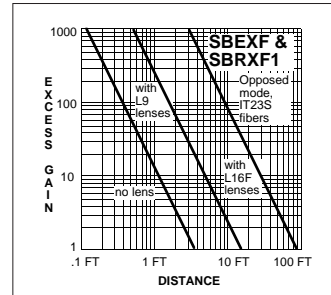

FIBER OPTIC Mode (glass fiber optics)

HIGH-POWER SCANNER BLOCK

OPPOSED MODE

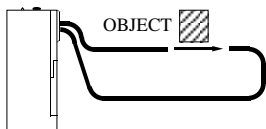

DIFFUSE MODE

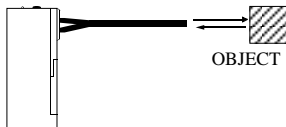

SBFX1

Range: see excess gain curves
Response: 10ms on/off
Repeatability: 1.5ms
Beam: infrared, 880nm

Fiber optic information:
IT13S: individual assembly .06 in. (1.5mm) dia. bundle
IT23S: individual assembly .12 in. (3mm) dia. bundle

BT13S: bifurcated assembly, .06 in. (1.5mm) dia. bundle
BT23S: bifurcated assembly, .12 in. (3mm) dia. bundle

L9: .5in. (12mm) dia. lens
L16F: 1.0 in. (25mm) dia. lens

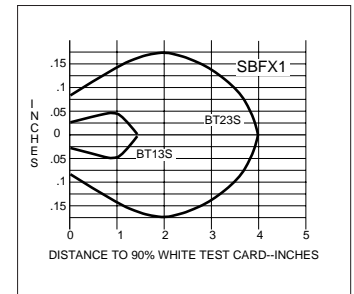
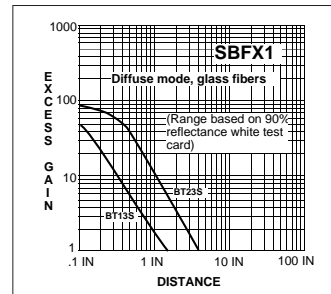
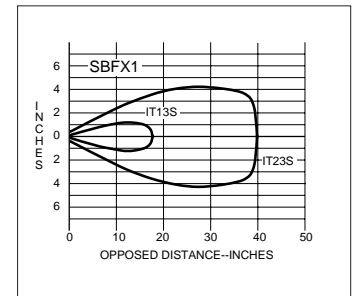
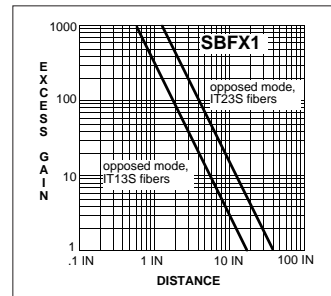

Model SBFX1 is the first choice for glass fiber optic applications, except in fiber optic retroreflective applications or where faster response speed or visible light are a requirement. Model SBFX1 contains both emitter and receiver and thus accepts either one bifurcated fiberoptic assembly or two individual fiber optic cables. The excess gain of model SBFX1 is the highest available in the photoelectric industry. As a result, opposed individual fibers operate reliably in many very hostile environments. Also, special miniature bifurcated fiber optic assemblies with bundle sizes as small as .020 inch (.5mm) in diameter may be used successfully with model SBFX1 for diffuse mode sensing. The excess gain curves and beam patterns illustrate response with standard .060 inch (1.5mm) diameter and .12 inch (3mm) diameter bundles. Response for smaller or larger bundle sizes may be interpolated. **NOTE:** opposed ranges shown are meant to illustrate excess gain only, and are limited by fiber length. Use scanner block models SBEXF and SBRXF1 (above) for long range opposed fiber optic sensing.

For complete information on glass fiber optic assemblies and accessories, see product catalog.