

Panasonic
ideas for life

**IC DRIVABLE PC BOARD
RELAY FOR FIELD LOAD
SWITCHING**

ST RELAYS

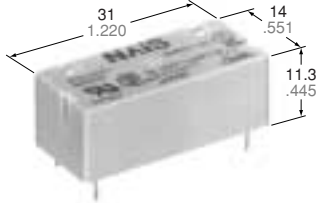

mm inch

FEATURES

- Sealed to meet the combination process of automatic wave soldering and cleaning needs
- Latching types available
- High switching capacity and high sensitivity in subminiature size
150 mW pick-up, 8 A inrush capacity: 51 A for 1a1b, 35 A for 2a
- High shock and vibration resistance
Shock: 20 G, Vibration: 10 to 55 Hz at double amplitude of 2 mm

SPECIFICATIONS

Contacts

| | | | |
|----------------------------------|--|--------------------------|---------------------|
| Arrangement | 1 Form A 1 Form B | 2 Form A | |
| Contact material | Gold flash over silver alloy | | |
| Initial contact resistance, max. | 30 mΩ | | |
| Rating (resistive) | Max. switching power | 2,000 VA, 150 W | |
| | Max. switching voltage | 380 V AC, 250 V DC | |
| | Max. switching current | 8 A | |
| | Min. switching capacity ^{#1} | 100 mA, 5 V DC | |
| HP rating | 1/4 HP 125, 250 V AC | | |
| Inrush current capability | 51 A (TV-3 equivalence) for 1a1b 35 A (TV-1 equivalence) for 2a | | |
| Expected life (min. operations) | Mechanical (at 180 cpm) | 10 ⁷ | |
| | Electrical | 8 A 250 V AC (resistive) | 10 ⁵ |
| | | 5 A 30 V DC (resistive) | 2 × 10 ⁵ |
| | | 3 A 100 V AC (lamp) | 3 × 10 ⁴ |
| | | 1 A 100 V AC (lamp) | — |

Coil (polarized) (at 25°C 77°F)

| | | |
|--------------------|-----------------------------|----------------|
| Single side stable | Nominal operating power | Approx. 240 mW |
| Latching | Nominal set and reset power | Approx. 240 mW |

#1 This value can change due to the switching frequency, environmental conditions, and desired reliability level, therefore it is recommended to check this with the actual load.

Remarks

- * Specifications will vary with foreign standards certification ratings.
- *1 Measurement at same location as "Initial breakdown voltage" section
- *2 Detection current: 10 mA
- *3 Wave is standard shock voltage of ±1.2 × 50μs according to JEC-212-1981
- *4 Excluding contact bounce time
- *5 Half-wave pulse of sine wave: 11ms; detection time: 10μs
- *6 Half-wave pulse of sine wave: 6ms
- *7 Detection time: 10μs
- *8 Refer to 6. Conditions for operation, transport and storage mentioned in AMBIENT ENVIRONMENT

Characteristics (at 25°C 77°F 50% Relative humidity)

| | | |
|--|--|--|
| Max. operating speed | 20 cpm (at rated load) | |
| Initial insulation resistance ^{*1} | 1,000 MΩ (at 500 V DC) | |
| Initial breakdown voltage ^{*2} | Between contact sets | 2,000 Vrms |
| | Between open contacts | 1,200 Vrms |
| | Between contacts and coil | 3,750 Vrms |
| Surge voltage between coil and contact ^{*3} | Min. 6,000 V | |
| Operate time ^{*4} (at nominal voltage) | Max. 15 ms (Approx. 10 ms) | |
| Release time (without diode) ^{*4} (at nominal voltage) | Max. 10 ms (Approx. 8 ms) | |
| Set time ^{*4} (latching) (at nominal voltage) | Max. 10 ms (Approx. 8 ms) | |
| Reset time ^{*4} (latching) (at nominal voltage) | Max. 10 ms (Approx. 8 ms) | |
| Temperature rise (at 60°C) | Max. 55°C with nominal coil voltage and at 8 A switching current | |
| Shock resistance | Functional ^{*5} | Min. 196 m/s ² {20 G} |
| | Destructive ^{*6} | Min. 980 m/s ² {100 G} |
| Vibration resistance | Functional ^{*7} | 117.6 m/s ² {12 G}, 10 to 55 Hz at double amplitude of 2 mm |
| | Destructive | 176.4 m/s ² {18 G}, 10 to 55 Hz at double amplitude of 3 mm |
| Conditions for operation, transport and storage ^{*8} (Not freezing and condensing at low temperature) | Ambient temp. | -40°C to +60°C -40°F to +140°F |
| | Humidity | 5 to 85% R.H. |
| Unit weight | Approx. 10g .353 oz | |

TYPICAL APPLICATIONS

Sequence controllers, facsimiles, telephone controls, remote control security devices and security equipment.

ORDERING INFORMATION

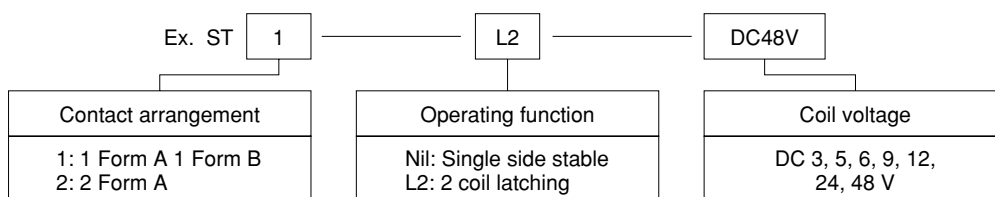

(Notes) 1. Standard packing: Carton; 50 pcs., Case; 500 pcs.
2. 1 coil latching type available.

TYPES AND COIL DATA (at 20°C 68°F)

Single side stable

| Part No. | | Nominal voltage, V DC | Pick-up voltage, V DC (max.) | Drop-out voltage, V DC (min.) | Maximum allowable voltage, V DC (60°C 140°F) | Coil resistance, Ω (±10%) | Nominal operating current, mA |
|----------------------|-----------|-----------------------|------------------------------|-------------------------------|--|---------------------------|-------------------------------|
| 1 Form A 1 Form B | 2 Form A | | | | | | |
| ST1-DC3V | ST2-DC3V | 3 | 2.4 | 0.3 | 4.5 | 38 | 78.9 |
| ST1-DC5V | ST2-DC5V | 5 | 4.0 | 0.5 | 7.5 | 105 | 47.6 |
| ST1-DC6V | ST2-DC6V | 6 | 4.8 | 0.6 | 9.0 | 150 | 40 |
| ST1-DC9V | ST2-DC9V | 9 | 7.2 | 0.9 | 13.5 | 360 | 25 |
| ST1-DC12V | ST2-DC12V | 12 | 9.6 | 1.2 | 18.0 | 600 | 20 |
| ST1-DC24V | ST2-DC24V | 24 | 19.2 | 2.4 | 36.0 | 2,400 | 10 |
| ST1-DC48V | ST2-DC48V | 48 | 38.4 | 4.8 | 72.0 | 9,000 | 5.3 |

2 coil latching

| Part No. | | Nominal voltage, V DC | Set and reset voltage, V DC (max.) | Maximum allowable voltage, V DC (60°C 140°F) | Coil resistance, Ω (±10%) | Nominal operating current, mA |
|----------------------|--------------|-----------------------|------------------------------------|--|---------------------------|-------------------------------|
| 1 Form A 1 Form B | 2 Form A | | | | | |
| ST1-L2-DC3V | ST2-L2-DC3V | 3 | 2.4 | 4.5 | 40 | 75 |
| ST1-L2-DC5V | ST2-L2-DC5V | 5 | 4.0 | 7.5 | 110 | 45.5 |
| ST1-L2-DC6V | ST2-L2-DC6V | 6 | 4.8 | 9.0 | 155 | 38.7 |
| ST1-L2-DC9V | ST2-L2-DC9V | 9 | 7.2 | 13.5 | 360 | 25 |
| ST1-L2-DC12V | ST2-L2-DC12V | 12 | 9.6 | 18.0 | 640 | 18.8 |
| ST1-L2-DC24V | ST2-L2-DC24V | 24 | 19.2 | 36.0 | 2,400 | 10 |
| ST1-L2-DC48V | ST2-L2-DC48V | 48 | 38.4 | 72.0 | 10,200 | 4.7 |

DIMENSIONS

mm inch

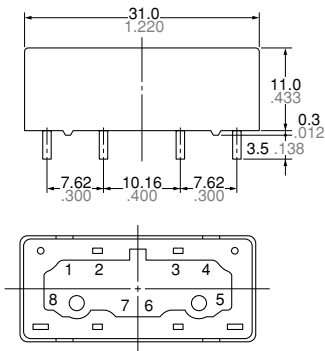

General tolerance: ±0.2 ±.008

PC board pattern (Copper-side view)

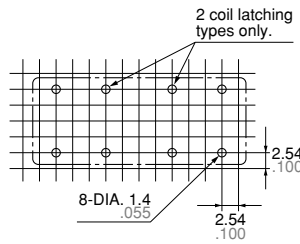

Tolerance: ±0.1 ±.004

Schematic (Bottom view) Single side stable

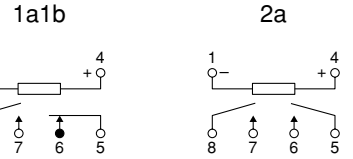

(Deenergized condition)

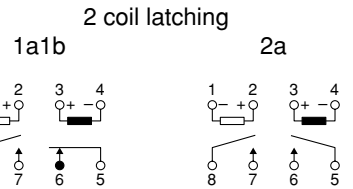

(Reset condition)

Diagram shows the "reset" position when terminals 3 and 4 are energized. Energize terminals 1 and 2 to transfer contacts.

Diagram shows the "reset" position when terminals 3 and 4 are energized. Energize terminals 1 and 2 to transfer contacts.

REFERENCE DATA

1. Max. switching power

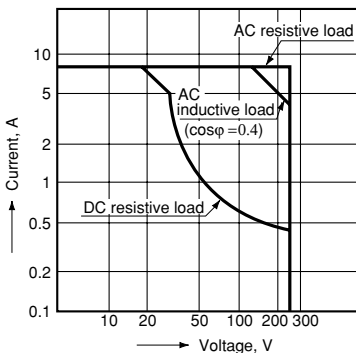

2. Life curve

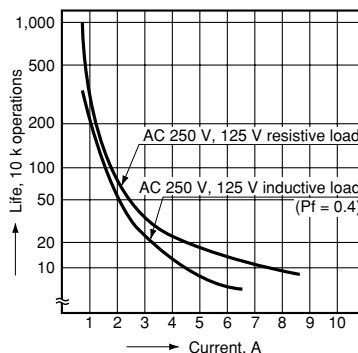

3. Coil temperature rise

Sample: ST1-DC24V

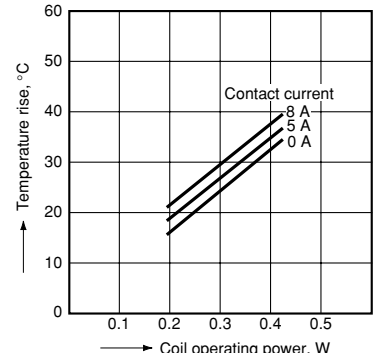

4. Influence of adjacent mounting

Sample: ST1-DC24V

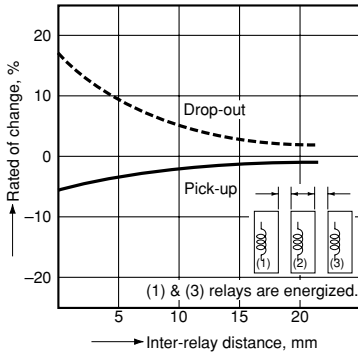

5. Max. ambient temperature by operating power

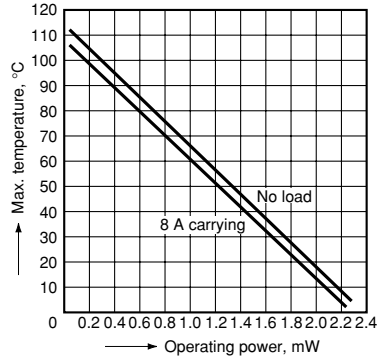

6. Contact reliability

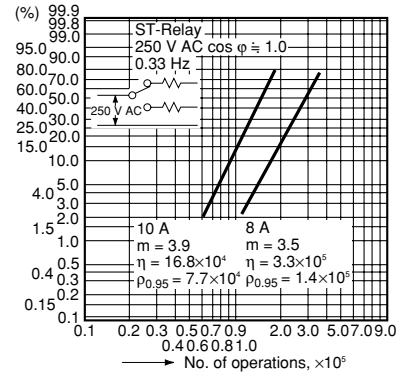

ST relay socket



ST-SS

Solder terminal socket



ST-PS

PC board terminal socket

Specifications

| | |
|-------------------------|--|
| Breakdown voltage | 4,000 Vrms Coil/Contacts 2,000 Vrms Contacts/Contacts |
| Insulation resistance | More than 1,000 MΩ between terminals |
| Heat resistance | 150°C (302°F) for 1 hr |
| Max. continuous current | 10 A |
| Relay insertion life | 15 times |

DIMENSIONS

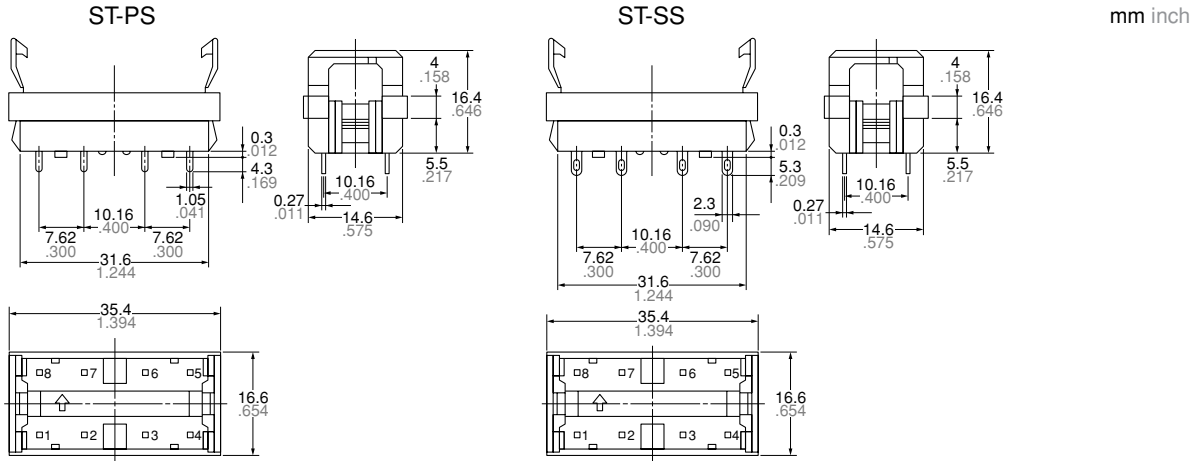

Precautions for use (socket)

1. PC board mounting method

PC board pattern



The terminal configuration is symmetrical on the left and right, so an arrow mark \uparrow is stamped on the socket to prevent mis-insertion. We recommend printing the same arrow mark \uparrow on the component mounting side (side opposite from pattern) of the PC board. In this case, the terminal nos. noted near the drilling holes.

2. Chassis cutout

Chassis cutting dimensions

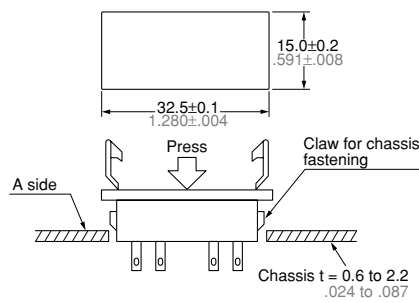

If the chassis hole is punched with a press, set so the release R on the front side (A side).

The range for chassis thickness is 0.6 to 2.2 mm .024 to .087 inch.

3. Relay mounting and removal

(1) Align the directions of the relay and socket.

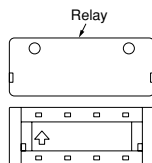

(2) Insert the relay all the way in, so it is securely in place.

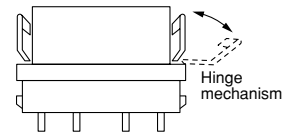

(3) Press the part indicated by A in the B direction, and fasten by placing the hook on the relay.

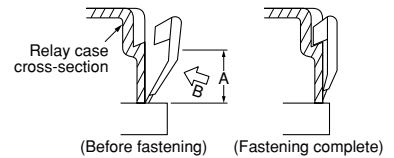

(4) When removing the relay, completely release the hooks on both sides and pull the relay out.