

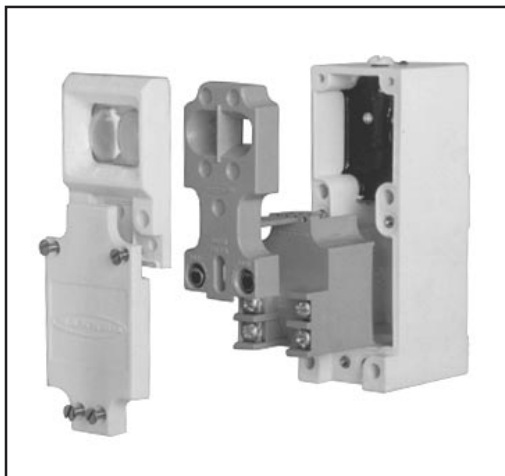

MULTI-BEAM[®] Sensors

Compact modular self-contained photoelectric sensing controls

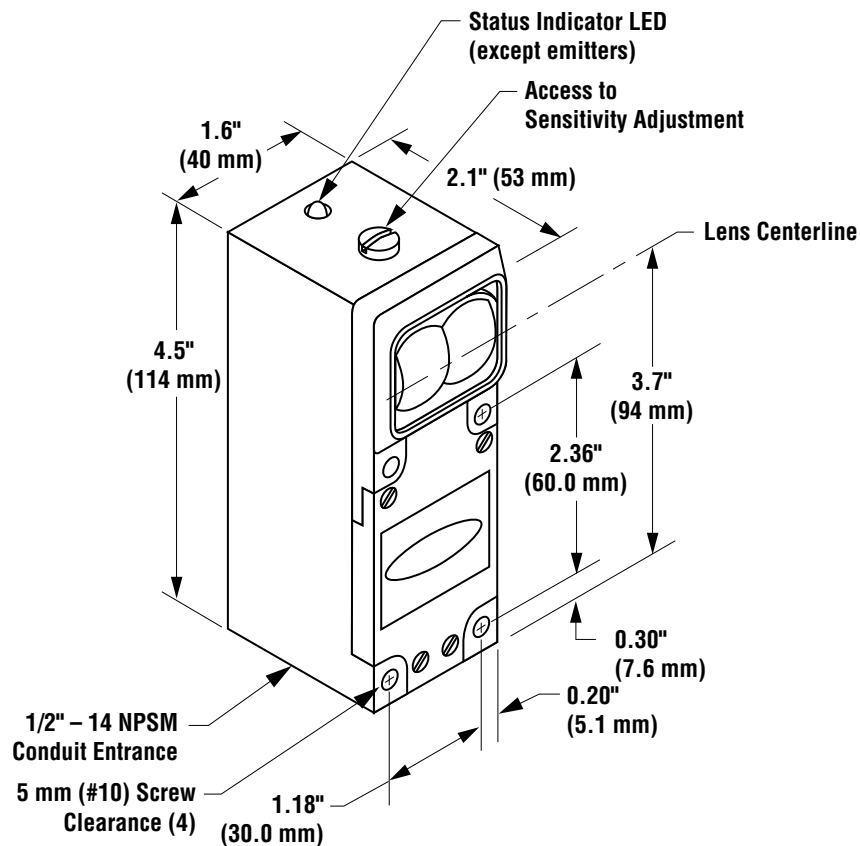

- Modular design with interchangeable components (scanner blocks, power blocks, and logic timing modules); over 5,000 sensor configurations possible
- *Scanner blocks* for opposed, retro, diffuse, convergent, and fiber optic sensing modes (including high-gain models)
- *Power blocks* for ac or dc operation, including 2-wire ac operation
- *Logic modules* to support a wide variety of delay, pulse, limit, and rate sensing logic functions
- Most scanner blocks include Banner's exclusive, patented AID™ (Alignment Indicating Device) system, which lights a top-mounted indicator LED whenever the sensor sees its own modulated light source, and pulses the LED at a rate proportional to the strength of the received light signal.

Contents

Introduction to MULTI-BEAM® Modular Sensors	page 3
Selection of components and summary of available models	pages 4-6
MULTI-BEAM® 3- and 4-wire Sensors	pages 6-23
3- and 4-wire Scanner Blocks	pages 6-14
3- and 4-wire Scanner Block modifications	page 14
3- and 4-wire Power Blocks	pages 15-20
3- and 4-wire Logic Modules	pages 21-23
MULTI-BEAM® 2-wire Sensors	pages 24-29
2-wire Scanner Blocks	pages 24-26
2-wire Power Blocks	pages 27-28
2-wire Logic Modules	page 29
MULTI-BEAM® Accessories	pages 30-31
Upper Covers (lens assemblies).....	page 30
Lower Covers	page 30
Mounting Brackets	page 31
Quick Disconnect	page 31



WARNING MULTI-BEAM® photoelectric presence sensors described in this catalog do NOT include the self-checking redundant circuitry necessary to allow their use in personnel safety applications. A sensor failure or malfunction can result in *either* an energized or a de-energized sensor output condition.

Never use these products as sensing devices for personnel protection. Their use as a safety device may create an unsafe condition which could lead to serious injury or death.

Only MACHINE-GUARD and PERIMETER-GUARD Systems, and other systems so designated, are designed to meet OSHA and ANSI machine safety standards for point-of-operation guarding devices. No other Banner sensors or controls are designed to meet these standards, and they must NOT be used as sensing devices for personnel protection.

WARRANTY: Banner Engineering Corporation warrants its products to be free from defects for one year. Banner Engineering Corporation will repair or replace, free of charge, any product of its manufacture found to be defective at the time it is returned to the factory during the warranty period. This warranty does not cover damage or liability for the improper application of Banner products. This warranty is in lieu of any other warranty either expressed or implied.

MULTI-BEAM[®] Sensors

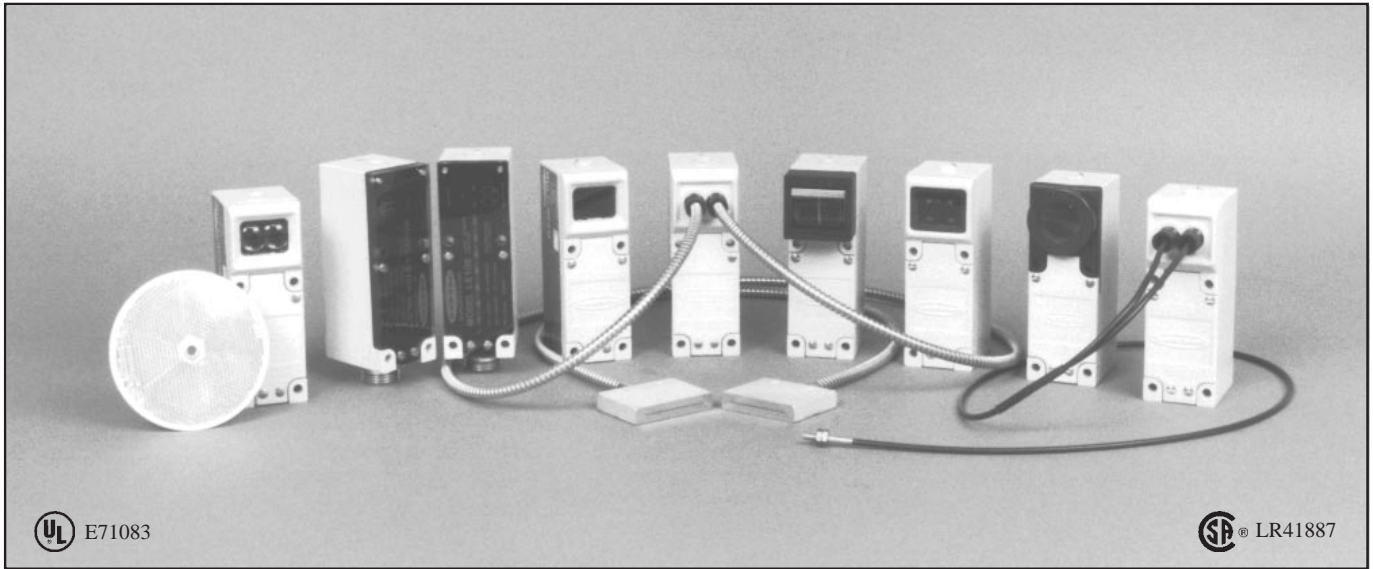

UL E71083

SP[®] LR41887

Banner MULTI-BEAM[®] sensors are compact *modular* self contained photoelectric switches. Each MULTI-BEAM consists of three components: scanner block, power block, and logic module. The *scanner block* contains the complete modulated photoelectric amplifier as well as the emitter and receiver optoelements. It also contains the sensing optics and the housing for the other two modules. The *power block* provides the interface between the scanner block and the external circuit. It contains a power supply for the MULTI-BEAM plus a switching device to interface the circuit to be controlled. The *logic module* interconnects the power block and scanner block both electrically and mechanically. It provides the desired timing logic function (if any), plus the ability to program the output for either light- or dark-operate. The emitters of MULTI-BEAM emitter-receiver pairs do not require a logic module. Emitter scanner blocks are supplied with a blade-pin to interconnect the scanner block and power block. This modular design, with field-replaceable power block and logic module, permits over 5,000 sensor configurations, resulting in exactly the right sensor for any photoelectric application.

There are two families of MULTI-BEAM sensors: 3- and 4-wire, and 2-wire. Three- and four-wire MULTI-BEAMS offer the greatest selection of sensor configurations. They permit either ac or dc operation and offer the fastest response times and the greatest sensing ranges. Two-wire MULTI-BEAMS are used in ac-powered applications where simplicity and convenience of wiring are important. They are physically *and* electrically interchangeable with heavy-duty limit switches.

The circuitry of all MULTI-BEAM components is encapsulated within rugged, corrosion-resistant VALOX[®] housings, which meet or exceed NEMA 1, 3, 12, and 13 ratings. Most MULTI-BEAM scanner blocks include Banner's patented Alignment Indicating Device (AID[™]) which lights a top-mounted LED when the sensor sees its own modulated light source and pulses the LED at a rate proportional to the received light signal. Most MULTI-BEAM sensor assemblies are UL listed and certified by CSA (see power block listings). All MULTI-BEAM components (except power block models 2PBR and 2PBR2) are totally solid-state for unlimited life.

Composite Functional Schematic, 3- and 4-wire Sensors

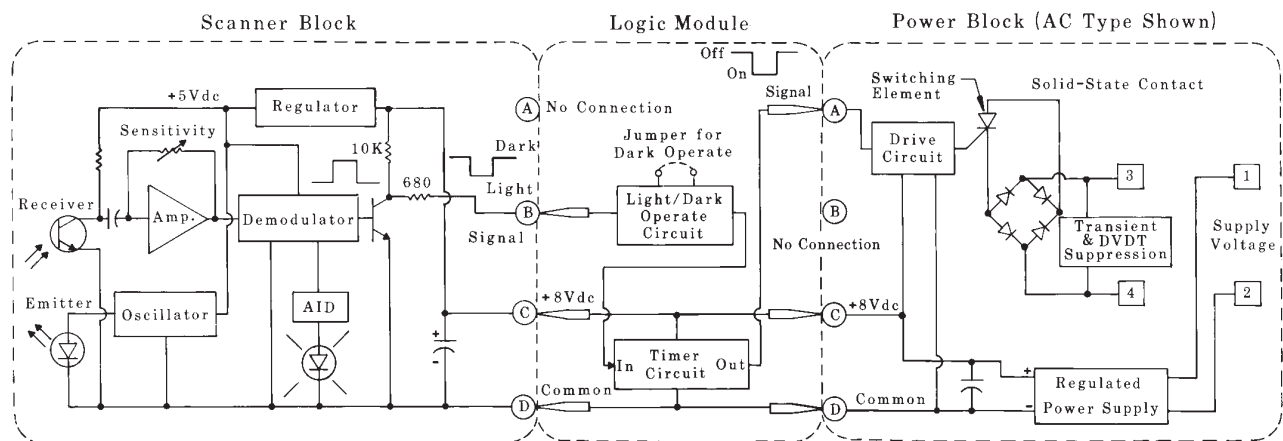

Selection of MULTI-BEAM Components

MULTI-BEAM sensors are made up of three components: scanner block, power block, and logic module. This is true for all MULTI-BEAMs with the exception of opposed mode emitter units which require only a power block (no logic module).

The first decision in the component selection process is to determine which family of MULTI-BEAM sensors is appropriate for the application: 3- and 4-wire, or 2-wire.

Next, decide which scanner block (within the selected family) is best for the application. The guidelines in the catalog introduction will help you to determine the best sensing mode. Then narrow the choice by comparing the specifications listed in the following charts and on the pages referenced in the charts.

Finally, choose a power block and logic module to complete the MULTI-BEAM assembly. Components snap together without inter-wiring to form a complete photoelectric sensing system that meets your exact requirements while maintaining the simplicity of a self-contained sensor.

If you have any questions about selecting MULTI-BEAM components, please contact your Banner sales engineer or call Banner's Applications Department at (612) 544-3164 during normal business hours.

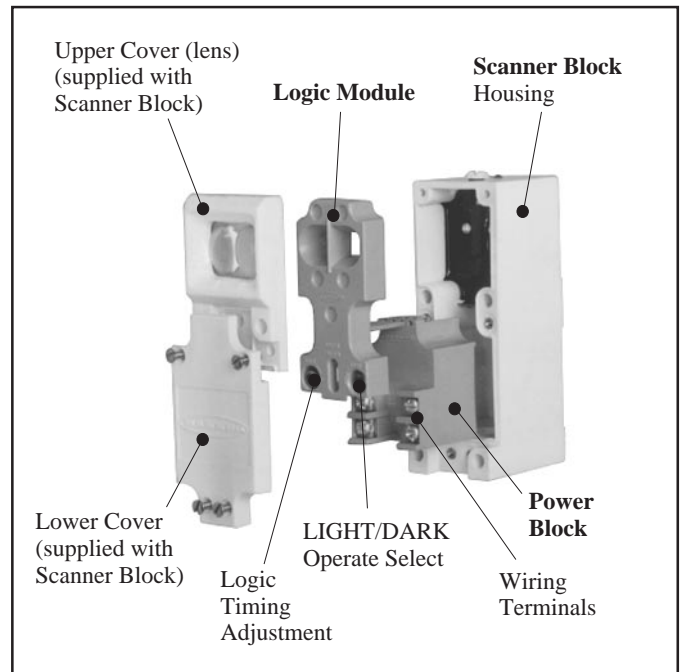

3- and 4-wire Systems (pages 6 through 23)

Scanner Blocks	Model	Sensing Mode	Range	Response	Page
	SBE & SBR1	Opposed: high speed	150 feet	1 millisecond	p. 7
	SBED & SBRD1	Opposed: high speed, narrow beam	10 feet	1 millisecond	p. 7
	SBEX & SBRX1	Opposed: high power, long range	700 feet	10 milliseconds	p. 7
	SBEV & SBRV1	Opposed: visible beam	100 feet	10 milliseconds	p. 7
	SBEXD & SBRXD1	Opposed: high power, wide beam angle	30 feet	10 milliseconds	p. 7
	SBLV1	Retroreflective: high speed, visible beam	30 feet	1 millisecond	p. 8
	SBLVAG1	Retroreflective: polarized beam (anti-glare)	15 feet	1 millisecond	p. 8
	SBL1	Retroreflective: high speed, infrared beam	30 feet	1 millisecond	p. 8
	SBLX1	Retroreflective: high power, long range	100 feet	10 milliseconds	p. 8
	SBD1	Diffuse (proximity): high speed	12 inches	1 millisecond	p. 9
SBDL1	Diffuse (proximity): medium range	24 inches	1 millisecond	p. 9	
SBDX1	Diffuse (proximity): high power, long range	6 feet	10 milliseconds	p. 9	
SBDX1MD	Diffuse (proximity): wide beam angle	24 inches	10 milliseconds	p. 9	
SBCV1	Convergent beam: high speed, visible red	1.5-inch focus	1 millisecond	p. 10	
SBCVG1	Convergent beam: high speed, visible green	1.5-inch focus	1 millisecond	p. 10	
SBC1	Convergent beam: high speed, infrared	1.5-inch focus	1 millisecond	p. 10	
SBC1-4	Convergent beam: high speed, infrared	4-inch focus	1 millisecond	p. 10	
SBC1-6	Convergent beam: high speed, infrared	6-inch focus	1 millisecond	p. 10	
SBCX1	Convergent beam: high power, infrared	1.5-inch focus	10 milliseconds	p. 10	
SBCX1-4	Convergent beam: high power, infrared	4-inch focus	10 milliseconds	p. 10	
SBCX1-6	Convergent beam: high power, infrared	6-inch focus	10 milliseconds	p. 10	
SBEF & SBRF1	Opposed fiber optic (glass fibers): high speed	see specs	1 millisecond	p. 11	
SBEXF & SBRXF1	Opposed fiber optic (glass fibers): high power	see specs	10 milliseconds	p. 11	
SBFX1	Fiber optic (glass fibers): high power, infrared	see specs	10 milliseconds	p. 11	
SBF1	Fiber optic (glass fibers): high speed, infrared	see specs	1 millisecond	p. 12	
SBF1MHS	Fiber optic (glass fibers): very high speed	see specs	0.3 millisecond	p. 12	
SBFV1	Fiber optic (glass fibers): visible red	see specs	1 millisecond	p. 13	
SBFVG1	Fiber optic (glass fibers): visible green	see specs	1 millisecond	p. 13	
SBAR1	Ambient light receiver	see specs	10 milliseconds	p. 14	
SBAR1GH	Ambient light receiver: high gain	see specs	10 milliseconds	p. 14	
SBAR1GHF	Ambient light receiver: for glass fiber optics	see specs	10 milliseconds	p. 14	

3- and 4-wire Systems (pages 6 through 23)

Power Blocks	Model	Input Voltage	Output Configuration	Agency Approvals	Page
	PBT	10 to 30V dc	SPST NPN (sink), 250mA maximum	UL & CSA	p. 15
	PBT2	10 to 30V dc	SPDT NPN (sink), 250mA each output		p. 15
	PBP	10 to 30V dc	SPST PNP (source), 250mA maximum	UL & CSA	p. 15
	PBT-1	10 to 30V dc	No output: for powering emitters	UL & CSA	p. 16
	PBT48	44 to 52V dc	SPST NPN (sink), 250mA maximum		p. 15
	PBP48	44 to 52V dc	SPST PNP (source), 250mA maximum		p. 15
	PBT48-1	44 to 52V dc	No output: for powering emitters		p. 16
	PBD-2	11 to 13V ac (50/60Hz)	SPST SCR, 3/4 amp maximum		p. 17
	PBD	22 to 28V ac (50/60Hz)	SPST SCR, 3/4 amp maximum	UL & CSA	p. 17
	PBD-1	22 to 28V ac (50/60Hz)	No output: for powering emitters		p. 19
	PBA	105 to 130V ac (50/60Hz)	SPST SCR, 3/4 amp maximum	UL & CSA	p. 17
	PBAQ	105 to 130V ac (50/60Hz)	SPST SCR, normally closed, 3/4 amp max.	UL & CSA	p. 19
	PBAT	105 to 130V ac (50/60Hz)	SPST isolated transistor, 100mA max. (ac or dc)	UL & CSA	p. 18
	PBO	105 to 130V ac (50/60Hz)	SPST isolated transistor, 50mA max. (dc only)	UL & CSA	p. 18
	PBAM	105 to 130V ac (50/60Hz)	Voltage source: 8V dc at 8ma max.	UL & CSA	p. 18
	PBA-1	105 to 130V ac (50/60Hz)	No output: for powering emitters	UL & CSA	p. 19
	PBB	210 to 250V ac (50/60Hz)	SPST SCR, 3/4 amp maximum	UL & CSA	p. 17
	PBBT	210 to 250V ac (50/60Hz)	SPST isolated transistor, 100mA max. (ac or dc)	UL & CSA	p. 18
PBOB	210 to 250V ac (50/60Hz)	SPST isolated transistor, 50mA max. (dc only)	UL & CSA	p. 18	
PBB-1	210 to 250V ac (50/60Hz)	No output: for powering emitters	UL & CSA	p. 19	

Logic Modules	Model	Timing Logic Function	Time Range(s)	Page
	LM1	ON/OFF (no timing function), light operate only	<i>NOTE for items below: other time ranges available (p. 23)</i>	p. 21
	LM3	ON/OFF (no timing function), light or dark operate		p. 21
	LM5	ON-delay	.15 to 15 seconds	p. 22
	LM5R	OFF-delay	.15 to 15 seconds	p. 22
	LM5-14	ON & OFF delay	.15 to 15 seconds (both delays)	p. 22
	LM5T	Limit timer (time-limited ON/OFF)	.15 to 15 seconds	p. 22
	LM4-2	One-shot, retriggerable	.01 to 1 second	p. 21
	LM4-2NR	One-shot, non-retriggerable	.01 to 1 second	p. 22
	LM8-1	Delayed one-shot	.15 to 15 seconds (both times)	p. 23
	LM8A	ON-delay one-shot	.15 to 15 seconds (both times)	p. 23
	LM6-1	Rate sensor	60 to 1200 pulses per minute	p. 22
	LM8	Repeat cycle timer	.15 to 15 seconds (both times)	p. 23
	LM2	Alternate action, divide by 2		p. 21
	LM10	Alternate action, divide by 10		p. 23
	LMT	Test module		p. 23

2-wire Systems (pages 24 through 29)

Scanner Blocks	Model	Sensing Mode	Range	Response	Page
	SBE & 2SBR	Opposed	150 feet	10 milliseconds	p. 25
	2SBL1	Retroreflective	30 feet	10 milliseconds	p. 25
	2SBD1	Diffuse (proximity): short range	12 inches	10 milliseconds	p. 26
	2SBDX1	Diffuse (proximity): long range	30 inches	10 milliseconds	p. 26
	2SBC1	Convergent beam	1.5-inch focus	10 milliseconds	p. 25
	2SBC1-4	Convergent beam	4-inch focus	10 milliseconds	p. 25
	2SBF1	Fiberoptic	see specs	10 milliseconds	p. 26

2-wire Systems (pages 24 through 29)

Power Blocks	Model	Input Voltage	Output Configuration	Agency Approvals	Page
	2PBD	22 to 28V ac (50/60Hz)	2-wire, SPST SCR, 3/4 amp max.	UL & CSA	p. 27
	2PBA	105 to 130V ac (50/60 Hz)	2-wire, SPST SCR, 3/4 amp max.	UL & CSA	p. 27
	2PBB	210 to 250V ac (50/60Hz)	2-wire, SPST SCR, 3/4 amp max.	UL & CSA	p. 27
	2PBR	105 to 130V ac (50/60Hz)	4-wire, SPST E/M relay, 5 amps max.		p. 27
	2PBR2	105 to 130V ac (50/60Hz)	4-wire, SPDT E/M relay, 5 amps max.		p. 27

Logic Modules	Model	Timing Logic Function	Time Range(s)	Page
	2LM3	ON/OFF (no timing)		p. 29
	2LM5	ON-delay	.15 to 15 seconds	p. 29
	2LM5R	OFF-delay	.15 to 15 seconds	p. 29
	2LM5-14	ON & OFF delay	.15 to 15 seconds (both delays)	p. 29
	2LM5T	Limit timer (time limited ON/OFF)	.15 to 15 seconds (both delays)	p. 29
	2LM4-2	One-shot, retriggerable	.01 to 1 second	p. 29
	LMT	Test module		p. 23

Other MULTI-BEAM Systems (described in Banner product catalog or in the data sheets noted below)

Edgewise Systems (data sheet 03506) Optical Data Transmitter (data sheet 03321) Light Screen System (data sheet 03557)

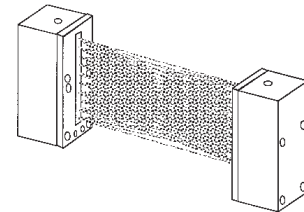
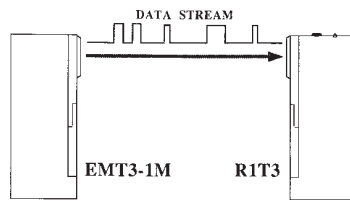
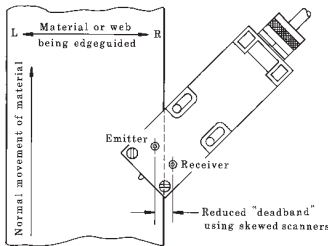

MULTI-BEAM 3- & 4-WIRE SCANNER BLOCKS

DESCRIPTION

MULTI-BEAM 3- & 4-wire scanner blocks offer a complete complement of sensing modes. There are 3 or more models for each sensing mode, resulting in a choice of exactly the right sensor for any application. The high power models (10 millisecond response time) offer greater optical sensing power than any other industrial sensors.

SPECIFICATIONS

SUPPLY VOLTAGE: input power and output connections are made via a 3- or 4-wire power block (see pages 15 to 20).

RESPONSE TIME: 1 millisecond ON and OFF, except high gain models with "X" suffix and ambient light receivers which are 10 milliseconds ON and OFF.

REPEATABILITY OF RESPONSE: see individual sensor specs.

SENSITIVITY ADJUSTMENT: easily accessible, located on top of scanner block beneath o-ring gasketed screw cover. 15-turn clutched control (rotate clockwise to increase gain).

ALIGNMENT INDICATOR: red LED on top of scanner block. Banner's exclusive, patented Alignment Indicating Device (AID™) circuit lights the LED whenever the sensor detects its own modulated light source, and pulses the LED at a rate proportional to the received light level.

CONSTRUCTION: reinforced VALOX® housing with components totally encapsulated. Stainless steel hardware. Meets NEMA standards 1, 3, 12, and 13.

OPERATING TEMPERATURE RANGE: -40 to +70 degrees C (-40 to +158 degrees F).

VALOX® is a registered trademark of General Electric Company.

Functional Schematic, 3- and 4-wire Scanner Block

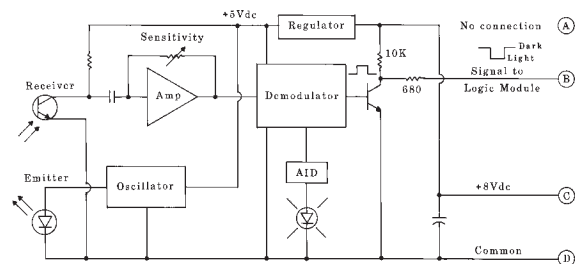

Dimensions, 3- and 4-wire Scanner Block

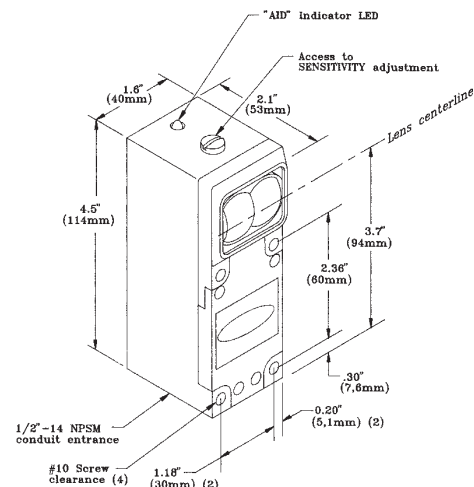

MULTI-BEAM 3- & 4-wire Scanner Blocks

Sensing Mode

Models

Excess Gain

Beam Pattern

OPPOSED Mode

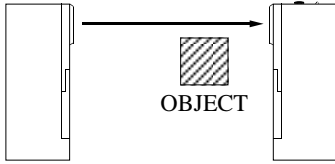

SBE/SBR1: this opposed pair has the highest gain available at 1 ms response.

SBED/SBRD1: fast response and small effective beam; will detect objects as small as .14 inch in crosssection moving at up to 10 feet per second. Best choice for repeatability of position sensing.

SBEX/SBRX1: best choice for opposed sensing in extremely dirty environments. Use for outdoor applications and all applications requiring opposed range of 100 feet or more. Also useable side-by-side for long-distance mechanical convergent sensing. Alignment difficult beyond 400 feet.

SBEV/SBRX1: SBEV has visible red beam for easiest alignment and system monitoring.

SBEXD/SBRXD1: wide beam angle and high gain for the most forgiving emitter-receiver alignment.



SBE & SBR1

Range: 150 feet (45m)
Response: 1ms on/off
Repeatability: 0.03ms
Beam: infrared, 940nm
Effective beam: 1" dia.

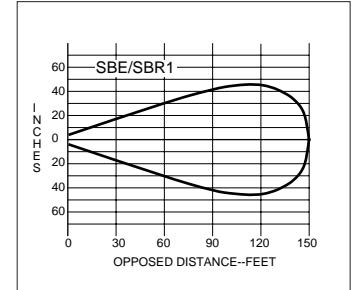
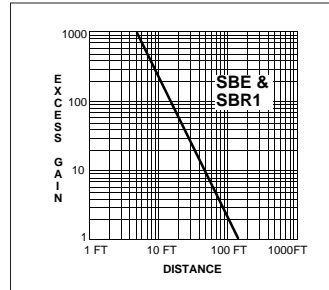

SBED & SBRD1

Range: 10 feet (3m)
Response: 1ms on/off
Repeatability: 0.03ms
Beam: infrared, 880nm
Effective beam: .14" dia.

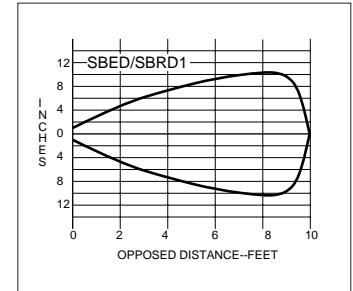
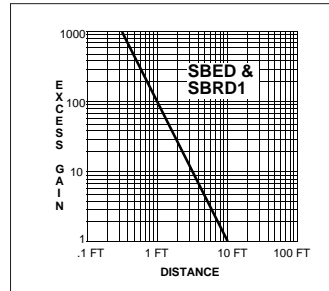

SBEX & SBRX1

Range: 700 feet (200m)
Response: 10ms on/off
Repeatability: 0.7ms
Beam: infrared, 940nm
Effective beam: 1" dia.

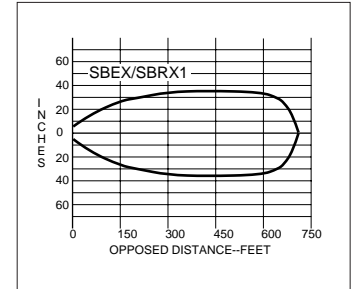
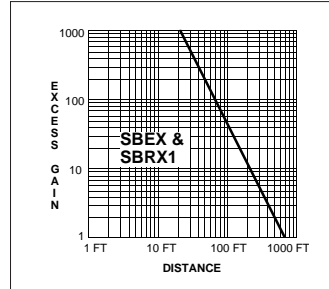

SBEV & SBRX1

Range: 100 feet (30m)
Response: 10ms on/off
Repeatability: 0.1ms
Beam: visible red, 650nm
Effective beam: 1" dia.

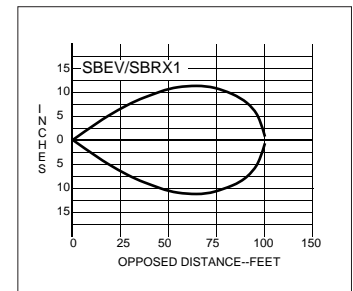
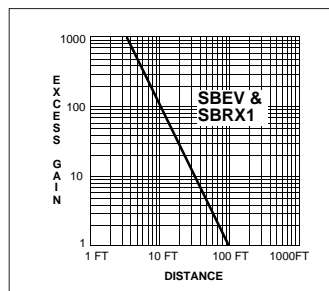

SBEXD & SBRXD1

Range: 30 feet (9m)
Response: 10ms on/off
Repeatability: 0.7ms
Beam: infrared, 880nm
Effective beam: .14" dia.

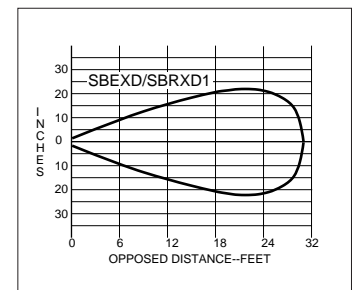
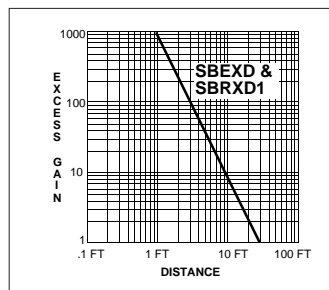

MULTI-BEAM 3- & 4-wire Scanner Blocks

Sensing Mode

Models

Excess Gain

Beam Pattern

RETROREFLECTIVE Mode

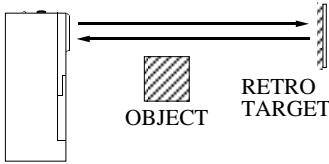

SBLV1: visible beam makes alignment very easy, and is the first choice for most retroreflective applications. Not for use in dirty environments; rather use opposed mode or see SBL1 & SBLX1, below. Do not locate retroreflector closer than 6 inches (15cm) from sensor.

SBLVAG1: uses anti-glare filter for immunity to direct reflections from shiny objects. Use only with models BRT-3 or BRT-1.5 retroreflective targets. Use only in clean environments. Do not locate retroreflector closer than 12 inches (30cm) from sensor.



SBLV1

Range: 6 in. to 30 ft.
(0,15 to 9m)
Response: 1ms on/off
Repeatability: 0.3ms
Beam: visible red, 650nm

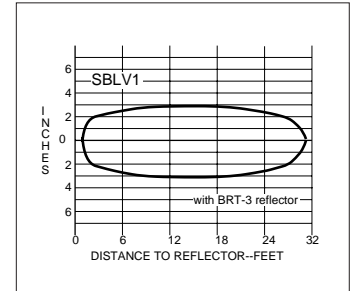
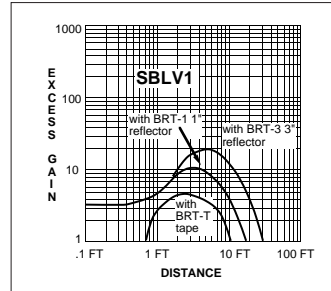

SBLVAG1

Range: 12 in. to 15 ft.
(0,3 to 4.5m)
Response: 1ms on/off
Repeatability: 0.3ms
Beam: visible red, 650nm

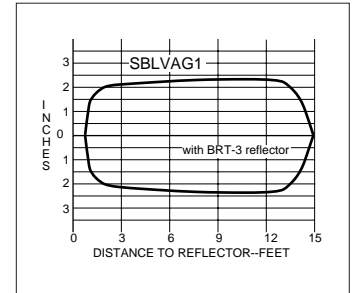
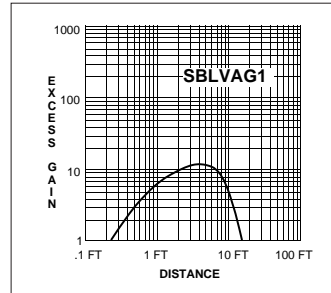

NOTE: for detailed information on available retroreflective materials, see the Banner product catalog.

SBL1: use where invisible beam is advantageous (e.g. security applications or film processing). First choice for retroreflective sensing in slightly or moderately dirty environments. Do not use when the object to break the beam has a shiny surface, unless the angle of light to the surface can be predicted.

SBLX1: highest gain available in a retroreflective sensor. Use for all applications requiring more than 30-foot range where opposed mode sensors cannot be used. Objects must pass at a distance of at least 10 feet from the sensor to be reliably sensed.

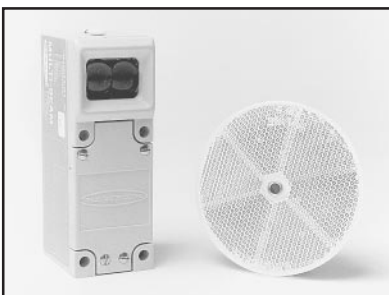

SBL1

Range: 1 in. to 30 ft.
(2,5cm to 9m)
Response: 1ms on/off
Repeatability: 0.3ms
Beam: infrared, 940nm

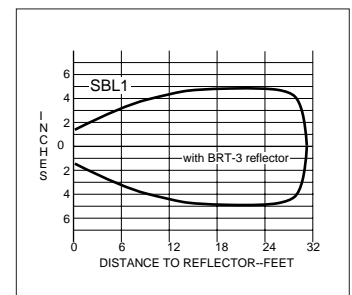
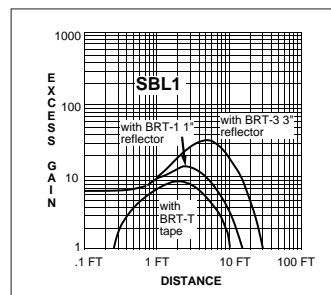

SBLX1

Range: 10 to 75 ft. (3 to 22m) with one BRT-3 target;
10 to 100 ft. (3 to 30m) with three BRT-3 targets
Response: 10ms on/off
Repeatability: 1.5ms
Beam: infrared, 880nm

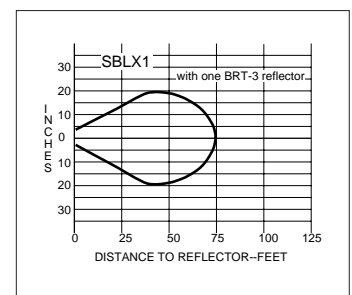
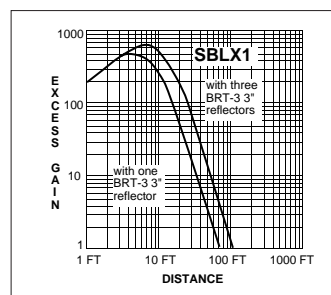

MULTI-BEAM 3- & 4-wire Scanner Blocks

Sensing Mode

Models

Excess Gain

Beam Pattern

DIFFUSE Mode

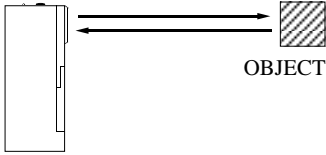

SBD1: short range diffuse mode sensor with relatively wide field of view. Loses gain rapidly near the end of its range. As a result, its response to background objects is suppressed. However, use caution when applying any diffuse mode sensor if background reflectivity exceeds the reflectivity of the object to be sensed.

SBDL1: longer range than SBD1, but with less response to objects passing the sensor at close range, and greater sensitivity to background objects. Models SBD1 and SBDL1 are identical except for their upper cover (lens) assembly (SBD1 uses UC-D; SBDL1 uses UC-L; see Upper Cover Chart in the Banner product catalog).



SBD1

Range: 12 inches (30cm)
Response: 1ms on/off
Repeatability: 0.3ms
Beam: infrared, 940nm

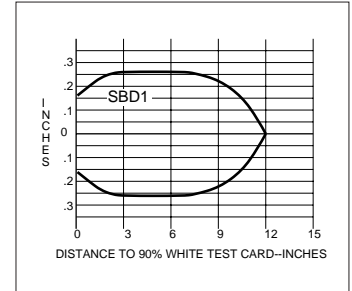
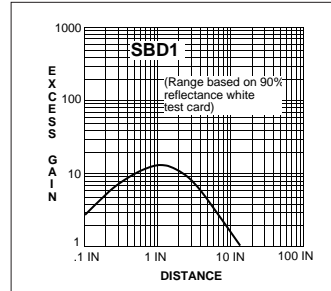

SBDL1

Range: 24 inches (60cm)
Response: 1ms on/off
Repeatability: 0.3ms
Beam: infrared, 940nm

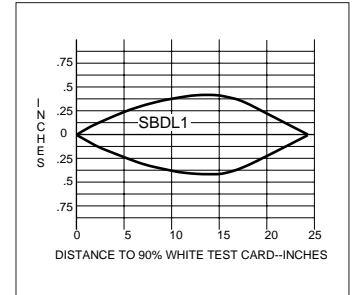
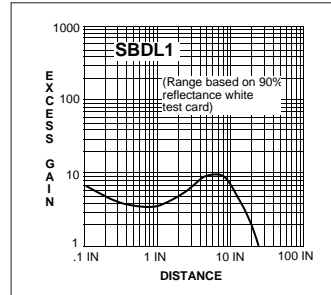

APPLICATION NOTE: as a general rule regarding background objects in diffuse sensing, verify that the distance to the nearest background object is at least three times the distance from the sensor to the object to be sensed. For example, if a product passes one inch from an SBD1 sensor, the nearest background object should be at least three inches further away.

SBDX1: first choice for diffuse (proximity) mode applications when there is no requirement for less than 10ms response and where there are no background objects to falsely return light. High excess gain for reliable detection of most materials with low reflectivity which pass within 10 inches (25cm) of the sensor.

SBDX1MD: wide beam angle for forgiving alignment to reflective objects. First choice for detection of clear or translucent glass or plastics. High excess gain at close range, with fast fall-off of gain near the maximum sensing distance for optical suppression of reflective background. This model may be created from model SBDX1 by substituting upper cover (lens) model UC-DMB.



SBDX1

Range: 6 feet (2m)
Response: 10ms on/off
Repeatability: 1.5ms
Beam: infrared, 880nm

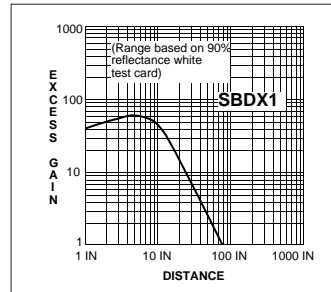

SBDX1MD

Range: 24 inches (60cm)
Response: 10ms on/off
Repeatability: 1.5ms
Beam: infrared, 880nm

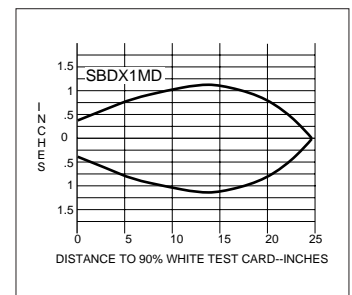
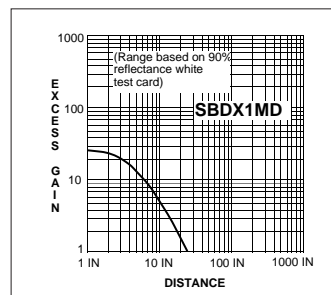

MULTI-BEAM 3- & 4-wire Scanner Blocks

Sensing Mode

Models

Excess Gain

Beam Pattern

CONVERGENT Mode

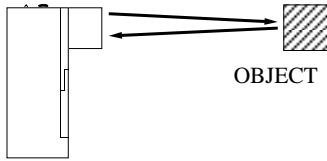

SBCV1: .06-inch (1.5mm) dia. visible red spot, for precise positioning, edge-guiding, & small parts detection. Sensor-to-product distance must be consistent. Some products ≥ 1 " tall may be sensed against immediate background like parts on a conveyor. Excellent for high-contrast registration-sensing applications (except red-on-white). Use with LM6-1 logic module for speed detection sensing gear teeth, pulley hubs, or chain links.

SBCVG1: .12-inch (3mm) diameter visible green spot. Use to detect color differences (e.g. color registration marks), including red-on-white combinations. For subtle shade variations, use model FO2BG (see Banner product catalog).



SBCV1
Focus at: 1.5 inch (38mm)
Response: 1ms on/off
Repeatability: 0.3ms
Beam: visible red, 650nm

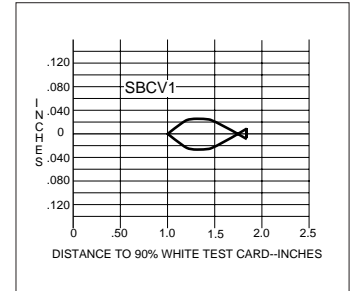
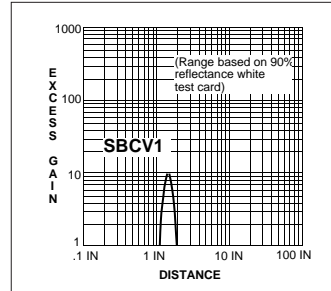

SBCVG1
Focus at: 1.5 in. (38mm)
Response: 1ms on/off
Repeatability: 0.3ms
Beam: visible green, 560nm

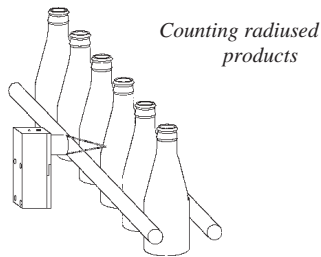
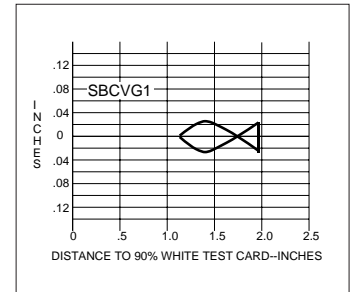
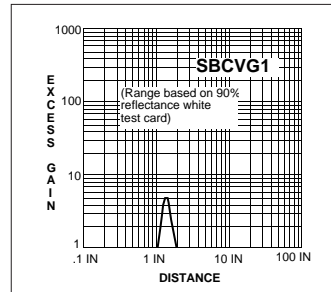

SBC1, SBC1-4, SBC1-6: infrared LED light source provides higher gain for reliable sensing of products of low reflectivity, while controlling sensing depth of field. Does not offer the same precision possible with visible light models. Good for sensing clear materials within the sensor's depth of field. Good for reliably counting the flow of radiused products which are kept at a fixed distance from the sensor (e.g. bottles against conveyor guide rail).

SBCX1, SBCX1-4, SBCX1-6: these models offer the greatest optical gain available in any reflective mode sensor. They reliably detect most non-reflective black materials in applications where opposed mode sensing is not possible (e.g. web break monitoring). Not meant for ignoring background objects (see excess gain charts).



SBC1
 Focus at: 1.5 inch (38mm)
SBC1-4
 Focus at: 4 inches (10cm)
SBC1-6
Focus at: 6 inches (15cm)
Response: 1ms on/off
Repeatability: 0.3ms
Beam: infrared, 940nm

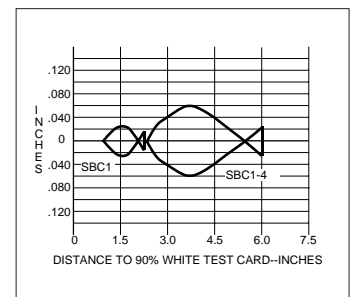
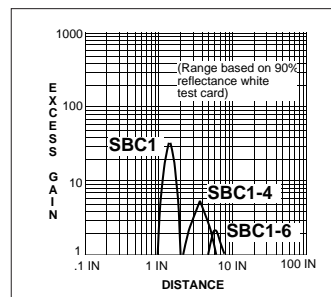

SBCX1
 Focus at: 1.5 inch (38mm)
SBCX1-4
 Focus at: 4 inches (10cm)
SBCX1-6
Focus at: 6 inch (15cm)
Response: 10ms on/off
Repeatability: 1.5ms
Beam: infrared, 880nm

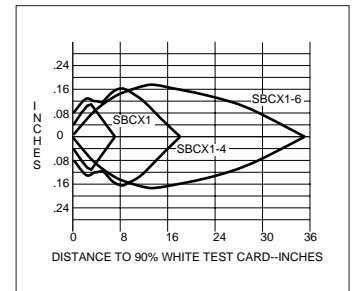
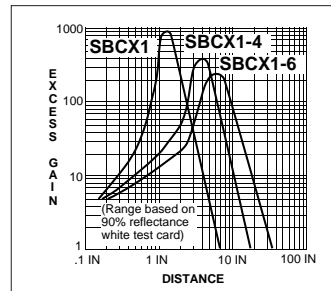

MULTI-BEAM 3- & 4-wire Scanner Blocks

Sensing Mode

Models

Excess Gain

Beam Pattern

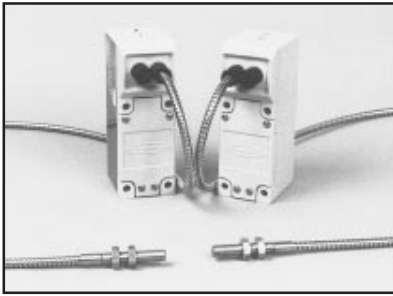

OPPOSED FIBER OPTIC Mode (glass fiber optics)

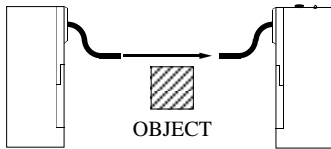

SBEF & SBRF1

Range: see excess gain curve
Response: 1ms on/off
Repeatability: 0.03ms
Beam: infrared, 880nm

NOTE: fiber optic gain curves apply to 3-foot fiber lengths. Gain decreases by approximately 10% for each additional foot of fiberoptic cable.

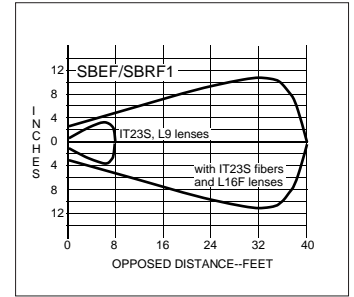
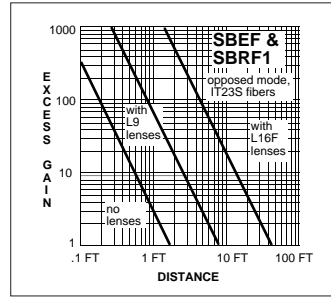

SBEF & SBRF1: use with individual glass fiber optic assemblies in lieu of model SBF1 where it is inconvenient to run fibers from a single scanner block.

SBEXF & SBRXF1: use in place of model SBFX1 (shown below) for long-range opposed fiber optic sensing. Or use where high excess gain is required and it is difficult to run the fibers to both sides of the process from a single scanner block. Lenses for fiber optics are shown in the Banner product catalog.

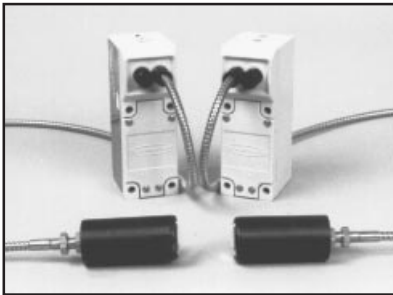

SBEXF & SBRXF1

Range: see excess gain curve
Response: 10ms on/off
Repeatability: 0.7ms
Beam: infrared, 880nm

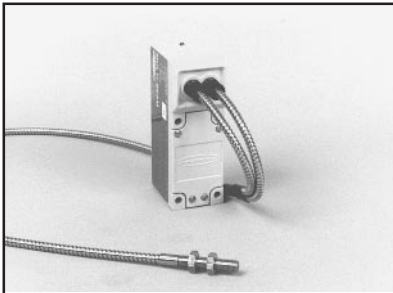
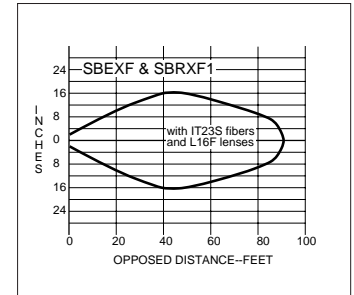
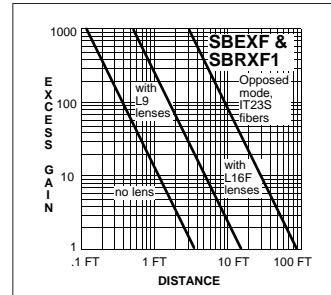

FIBER OPTIC Mode (glass fiber optics)

HIGH-POWER SCANNER BLOCK

OPPOSED MODE

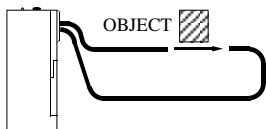

DIFFUSE MODE

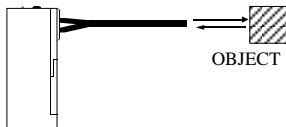

SBFX1

Range: see excess gain curves
Response: 10ms on/off
Repeatability: 1.5ms
Beam: infrared, 880nm

Fiber optic information:
IT13S: individual assembly .06 in. (1.5mm) dia. bundle
IT23S: individual assembly .12 in. (3mm) dia. bundle

BT13S: bifurcated assembly, .06 in. (1.5mm) dia. bundle
BT23S: bifurcated assembly, .12 in. (3mm) dia. bundle

L9: .5in. (12mm) dia. lens
L16F: 1.0 in. (25mm) dia. lens

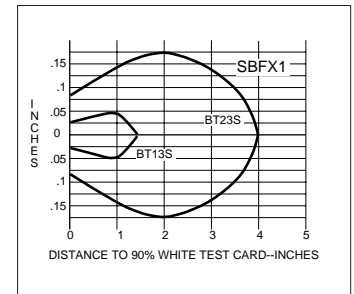
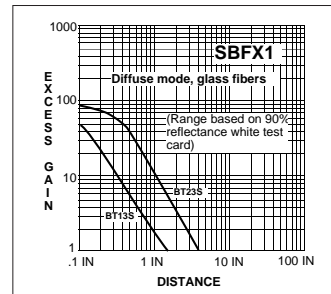
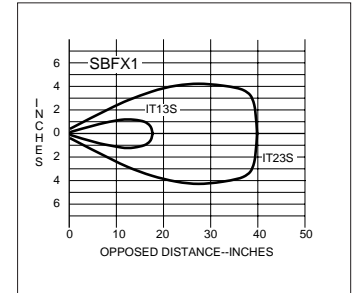
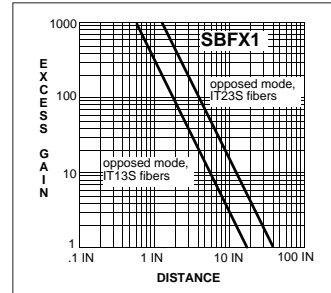

Model SBFX1 is the first choice for glass fiber optic applications, except in fiber optic retroreflective applications or where faster response speed or visible light are a requirement. Model SBFX1 contains both emitter and receiver and thus accepts either one bifurcated fiberoptic assembly or two individual fiber optic cables. The excess gain of model SBFX1 is the highest available in the photoelectric industry. As a result, opposed individual fibers operate reliably in many very hostile environments. Also, special miniature bifurcated fiber optic assemblies with bundle sizes as small as .020 inch (.5mm) in diameter may be used successfully with model SBFX1 for diffuse mode sensing. The excess gain curves and beam patterns illustrate response with standard .060 inch (1.5mm) diameter and .12 inch (3mm) diameter bundles. Response for smaller or larger bundle sizes may be interpolated. **NOTE:** opposed ranges shown are meant to illustrate excess gain only, and are limited by fiber length. Use scanner block models SBEXF and SBRXF1 (above) for long range opposed fiber optic sensing.

For complete information on glass fiber optic assemblies and accessories, see product catalog.

MULTI-BEAM 3- & 4-wire Scanner Blocks

Sensing Mode

Models

Excess Gain

Beam Pattern

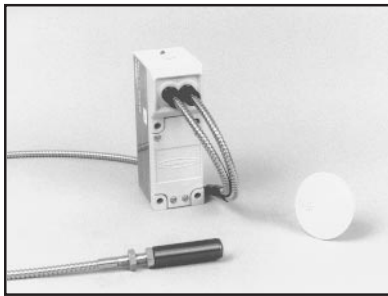

FIBER OPTIC Mode (glass fiber optics)

HIGH-SPEED SCANNER BLOCK

OPPOSED MODE

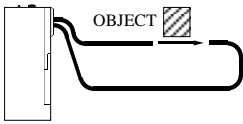

RETROREFLECTIVE MODE

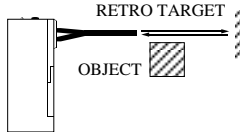

DIFFUSE MODE

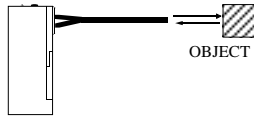

SBF1

Range: see excess gain curves
Response: 1ms on/off
Repeatability: 0.3ms
Beam: infrared, 940nm

Fiber optic information:
IT13S: individual assembly .06in. (1.5mm) dia. bundle
IT23S: individual assembly .12 in. (3mm) dia. bundle
BT13S: bifurcated assembly, .06 in. (1.5mm) dia. bundle
BT23S: bifurcated assembly, .12 in. (3mm) dia. bundle

L9: .5in. (12mm) dia. lens
L16F: 1.0 in. (25mm) dia. lens

For information on the complete line of glass fiber optics, see Banner product catalog.

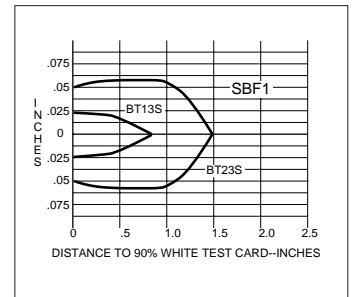
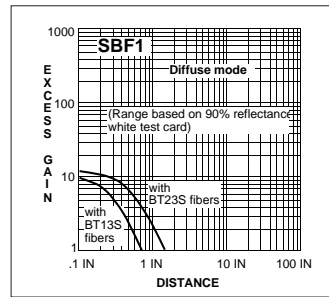
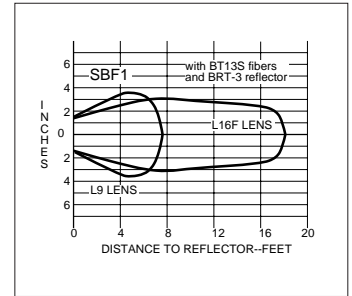
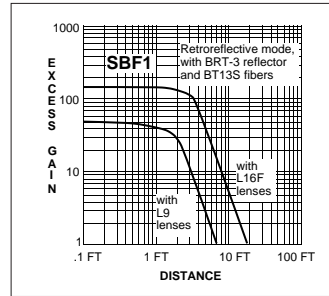
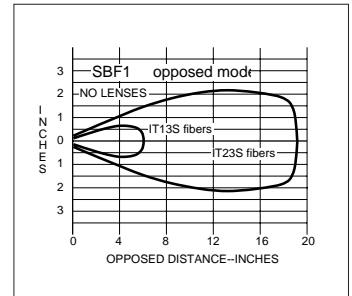
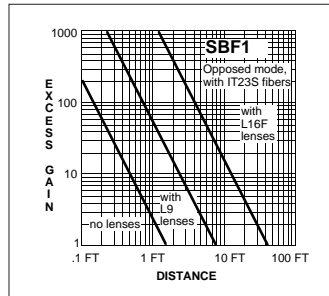

Fiber optics are often used to sense small parts. Small parts or narrow profiles which move at a high rate of speed can require sensors with fast response times for reliable detection. High speed fiber optic sensors are ideal for sensing gear or sprocket teeth or other targets in applications involving counters or shift registers for position control. Selection of the fiber optic sensing tip should involve matching the effective beam of the fiber to the profile of the part to be sensed to maximize the time that the part is sensed and/or the time between adjacent parts. Combining the best selection of fiber tip geometry with a high speed sensor will result in a highly repeatable position sensing system. The model BT13S fiber optic assembly used with a model L9 or L16F lens and a high speed scanner block is an excellent system for retroreflective code reading or for almost any short range retroreflective sensing application. Response time of a MULTI-BEAM sensor is also a function of the power block. For this reason, only power blocks which switch dc (e.g. PBT, PBP, PBO, PBAT, etc) should be used if the fast response time of the scanner block is to be utilized.

FIBER OPTIC Mode (glass fiber optics)

VERY HIGH-SPEED SCANNER BLOCK

OPPOSED MODE

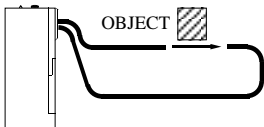

DIFFUSE MODE

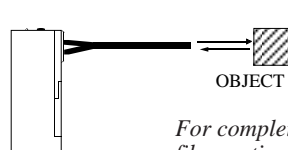

SBF1MHS

Range: see excess gain curves
Response: 300 microseconds on/off
Repeatability: 100 microseconds
Beam: infrared, 940nm

NOTE: gain curves illustrate that faster response comes at the expense of lower gain.

For complete information on glass fiber optic assemblies and accessories, see Banner product catalog.

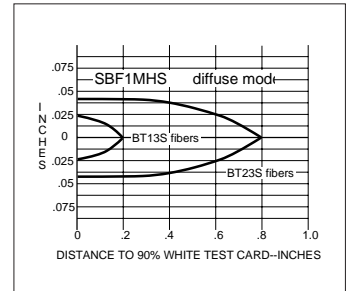
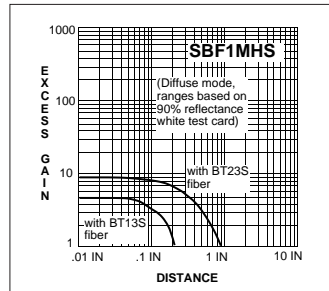
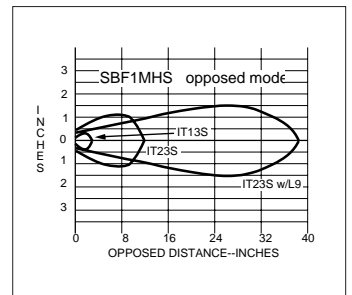
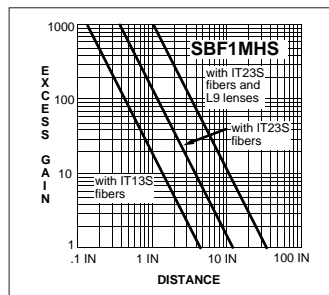

MULTI-BEAM 3- & 4-wire Scanner Blocks

Sensing Mode

Models

Excess Gain

Beam Pattern

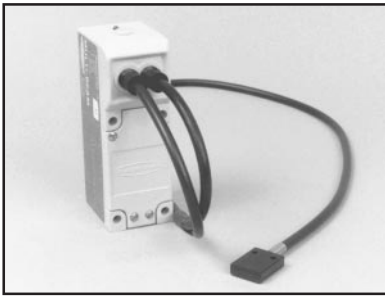

SBFV1
Range: see excess gain curves
Response: 1ms on/off
Repeatability: 0.3ms
Beam: visible red, 650nm

Fiber optic information:
IT13S: individual assembly .06in (1.5mm) dia. bundle
IT23S: individual assembly .12 in. (3mm) dia. bundle
BT13S: bifurcated assembly, .06 in. (1.5mm) dia. bundle
BT23S: bifurcated assembly, .12 in. (3mm) dia. bundle

L9: .5in. (12mm) dia. lens
L16F: 1.0 in. (25mm) dia. lens

For information on the complete line of glass fiber optics, see Banner product catalog.

FIBER OPTIC Mode (glass fiber optics)

VISIBLE RED LIGHT SOURCE

OPPOSED MODE

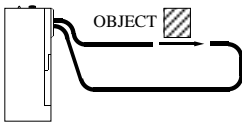

RETROREFLECTIVE MODE

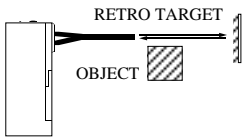

DIFFUSE MODE

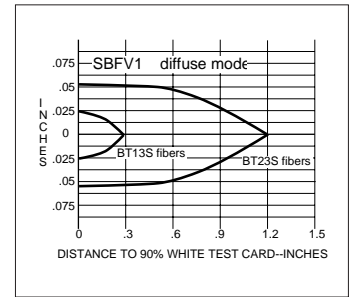
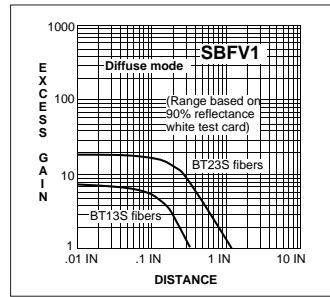
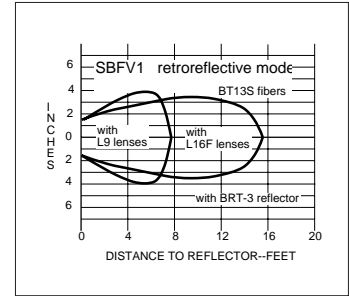
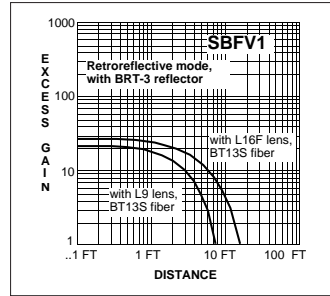
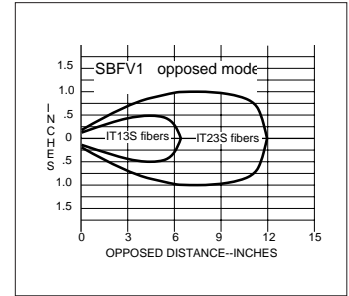
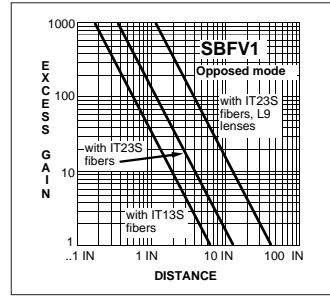
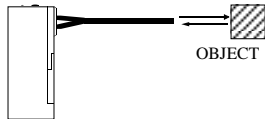

Scanner block model SBFV1 supplies visible red light to the emitter half of a glass fiber optic photoelectric system. Visible light sensors have less optical energy as compared to infrared systems. There are, however, some sensing situations which require visible light wavelengths in order to realize adequate optical contrast. Opposed fibers using visible red light are used to reliably sense translucent materials (e.g. plastic bottles) which appear transparent to infrared opposed sensors. Fiber assembly model BT13S used with the model L9 or L16F lens makes an excellent visible light sensing system for retroreflective code reading as well as many short-range retroreflective applications (e.g. retro scanning across a narrow conveyor). When combined with a bifurcated fiber, model SBFV1 may be used for color registration sensing for applications where there is a large difference between the two colors (e.g. black-on-white). For combinations of red-on-white, however, the visible-green light source of model SBFVG1 (below) is needed. Visible light emitters are also helpful for visual system alignment and maintenance.

FIBER OPTIC Mode (glass fiber optics)

VISIBLE GREEN LIGHT SOURCE for COLOR SENSING (REGISTRATION CONTROL)

SBFVG1
Range: see excess gain curve
Response: 1 ms on/off
Repeatability: 0.3ms
Beam: visible green, 560nm

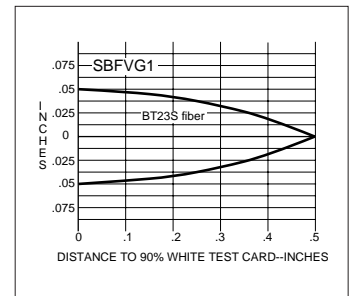
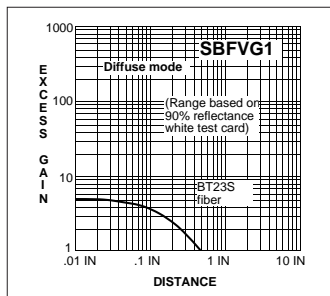
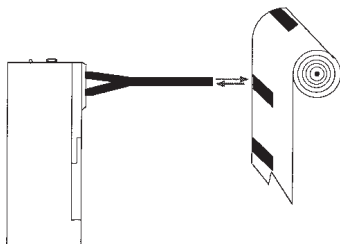

Convergent beam sensors like model SBCVG1 are often used for color registration sensing. However, there are some registration applications where the use of bifurcated fiber optics is beneficial. Fiber optics are able to fit into tight locations which are too small for a convergent sensor. Fibers also allow a choice of image size. It is important to create an image size which is smaller than the registration mark in order to maximize optical contrast and to ease sensor response requirements. Fibers allow a match of the light image to the geometry of the registration mark. Scanner block model SBFVG1 will sense most bold color differences, including red-on-white. Use only power blocks which switch dc (e.g. PBT, PPB, PBO, PBAT, etc.) for fast response.

MULTI-BEAM 3- & 4-wire Scanner Blocks

Sensing Mode

Models



AMBIENT LIGHT RECEIVER

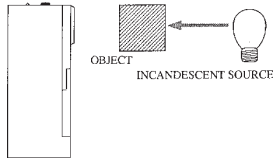

NOTE: MULTI-BEAM ambient light receivers do not have the Alignment Indicating Device (AID™) signal strength feature. The alignment indicator is "ON" steadily when enough light is sensed.

SBAR1

Response: 10ms on/off
Amplifier: normal gain
Optical response: ultra-violet through near infrared (includes all visible wavelengths)

SBAR1GH

Response: 10ms on/off
Amplifier: high gain
Optical response: ultra-violet through near infrared (includes all visible wavelengths)

Functional Schematic

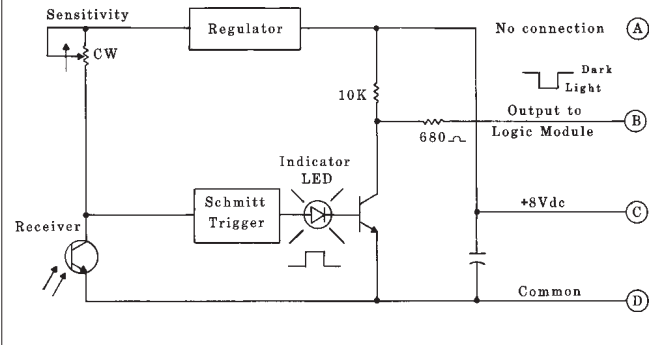

These scanner blocks are non-modulated receivers which are operated by sunlight or incandescent, fluorescent, infrared, or laser sources. A typical application would involve mounting the scanner block underneath a roller conveyor, "looking" up between the rollers at the overhead factory lighting. Any objects passing over the sensor would then cast a shadow, resulting in an output (dark operate). Ambient receivers are used with LM5-14 delay logic to sense daylight for outdoor lighting control. These sensors can also sense the large amounts of infrared light (heat energy) which is emitted by hot or molten glass, metal, or plastic during processing of these materials.

Model SBAR1 is for general application. Model SBAR1GH is a high gain version. It is about twenty times more sensitive to light as compared to the SBAR1. The range at which either model will sense a light source depends upon both the intensity of the light source and the contrast in intensity between the source and the rest of the ambient light in the viewing area.

NOTE: ambient receiver scanner blocks will also work with 2-wire power blocks and logic. However, the light/dark operate functions will be reversed when using 2-wire components.

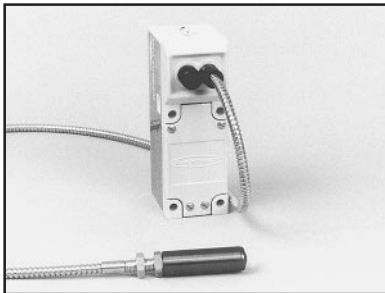

FIBER OPTIC AMBIENT LIGHT RECEIVER (glass fiber optics)

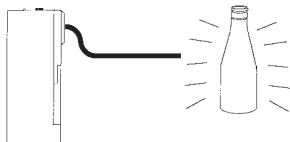

For information on the complete selection of individual glass fiber optics, see Banner product catalog.

SBAR1GHF

Response: 10ms on/off
Amplifier: high gain
Optical response: wavelengths from visible blue through near infrared

Direct Sensing of Radiant Infrared Energy

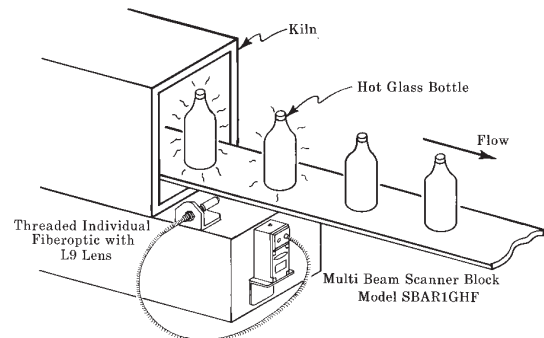

Counting bottles during the manufacturing process by detecting infrared (heat) radiation with an ambient light receiver.

Model SBAR1GHF is identical to model SBAR1GH (above) except that it is equipped with an upper cover assembly (model UC-RF) which allows an individual glass fiber optic assembly to be attached to the receiver optoelement. This model is used for ambient light detection in locations which are either too confined or too hot for mounting of the complete scanner block. A typical application involves sensing product presence or counting during processing of red-hot or molten glass or metal. The addition of an L9, L16F, L16FAL, or L16FSS lens to a threaded fiber assembly (e.g. IT23S) can narrow the angle of light acceptance to less than the angle of the SBAR1 lens. The high gain amplifier of model SBAR1GHF helps to offset light losses which are experienced with fiberoptic light pipes. *NOTE:* glass fibers will not efficiently pass ultraviolet wavelengths.

MULTI-BEAM 3- and 4-wire Scanner Block Modifications

The following are popular modifications to MULTI-BEAM 3- & 4-wire scanner blocks. They are not stocked, but are available on a quote basis.

HIGH SPEED MODIFICATION "MHS": scanner blocks with 1 millisecond response may be modified for 300 microsecond (0.3 millisecond) response. This modification is designated by adding suffix "MHS" to the scanner block model number (e.g.- SBF1MHS, etc.). High speed is most often required in fiberoptic or opposed mode sensing. The MHS modification reduces the available excess gain by about 50%, and also decreases the sensor's immunity to some forms of electrical "noise".

ZERO HYSTERESIS MODIFICATION "MZ": amplifier hysteresis may be removed from 3- and 4-wire scanner blocks when attempting to sense very small signal changes (contrasts less than 3). This modification is designated by adding suffix "MZ" (Modified Zero Hysteresis). Be sure that all variables affecting the sensor's optical response remain constant before ordering the zero hysteresis modification.

MULTI-BEAM 3- & 4-wire DC Power Blocks

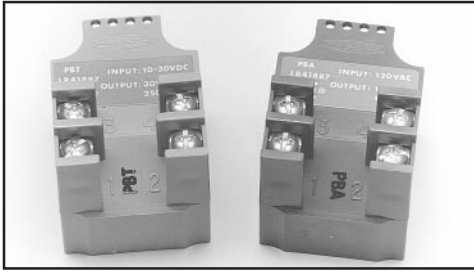

MULTI-BEAM 3- & 4-wire power blocks provide regulated low voltage DC power to the scanner block and logic module, and a solid state infinite-life switch (except in emitter-only scanner blocks). Connections are made to heavy-duty screw terminals which accept up to #14 gauge wire (no lugs are necessary). All power blocks are epoxy-encapsulated and rated for -40 to +70 degrees C. Response times are determined by the scanner block used, except that power blocks switching ac require up to 8.3 milliseconds to turn OFF in addition to the response time of the scanner block (plus logic module time delays, if any).

Photo shows DC power block (left) and AC power block (right). DC power blocks have gray housings; AC models are red.

DC Models

Connections

Functional Schematics

PBT

Input: 10 to 30V dc at less than 60mA (current draw depends on scanner block used). 10% max. ripple.
Output: one open-collector NPN transistor (sinks current to negative side of power supply). 250mA maximum.
On state voltage drop: less than 1V dc
Off state leakage current: less than 10 microamps

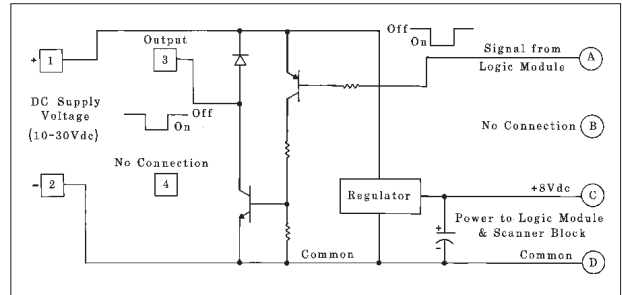
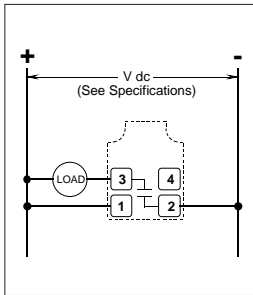

PBT48

Input: 44 to 52V dc at less than 60mA (current draw depends on scanner block used). 10% max. ripple.
Output: one open-collector NPN transistor (sinks current to negative side of power supply). 250mA maximum.
On state voltage drop: less than 1V dc
Off state leakage current: less than 10 microamps

PBT: the most commonly used dc power block. Its output is an NPN transistor, which sinks current to the negative side of the power supply. The load is connected between the output and the positive side of the power supply. Switching capacity is 250mA. There is no connection to terminal #4.

PBT48: exactly the same configuration as the PBT, but for 48V dc systems.

PBT2: provides two NPN outputs; one normally open, the other normally closed (equivalent to SPDT relay). The normally closed output may be used when a load must de-energize when the MULTI-BEAM operates (e.g. normally closed one-shot). NOTE: both outputs are open when dc power is removed.

PBT2

Input: 10 to 30V dc at less than 60mA (current draw depends on scanner block used). 10% max. ripple.
Output: two open-collector NPN transistors (one normally open, one normally closed). 250mA maximum, each output.
On state voltage drop: less than 1V dc
Off state leakage current: less than 10 microamps

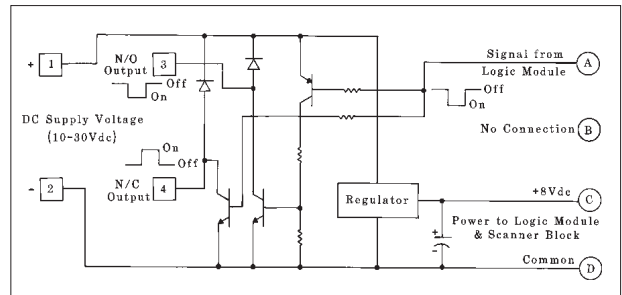
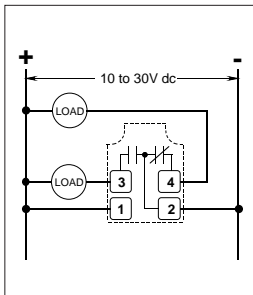

PBP

Input: 10 to 30V dc at less than 60mA (current draw depends on scanner block used). 10% max. ripple.
Output: one open-collector PNP transistor (sources current from positive side of power supply). 250mA maximum.
On state voltage drop: less than 1V dc
Off state leakage current: less than 10 microamps

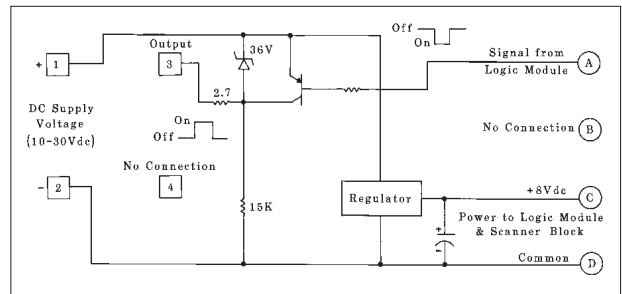
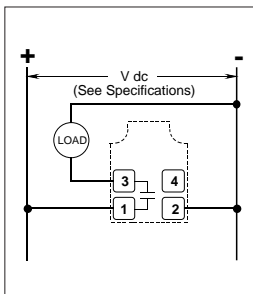

PBP48

Input: 44 to 52V dc at less than 60mA (current draw depends on scanner block used). 10% max. ripple.
Output: one open-collector PNP transistor (sources current from positive side of power supply). 250mA maximum.
On state voltage drop: less than 1V dc
Off state leakage current: less than 10 microamps

PBP: similar to model PBT, except that it provides a PNP sourcing type output transistor. Sourcing outputs are frequently required when interfacing to logic systems and programmable logic controllers (PLCs) which require a positive source of dc voltage to generate an input condition. This type of interface may also be accomplished by using PBT with a "pullup" resistor installed between terminals #1 and #3.

PBP48: a 48V dc version of model PBP.

MULTI-BEAM 3- & 4-wire DC Power Blocks

DC Models

Connections

Functional Schematic

These are power blocks for emitter scanner blocks only (models SBE, SBED, SBEX, SBEV, SBEXD, SBEF, SBEXF). Emitter assemblies do not require logic modules.

PBT-1

Input: 10 to 30V dc at less than 60mA (current draw depends on scanner block used). 10% max. ripple.

PBT48-1

Input: 44 to 52V dc at less than 60mA (current draw depends on scanner block used). 10% max. ripple.

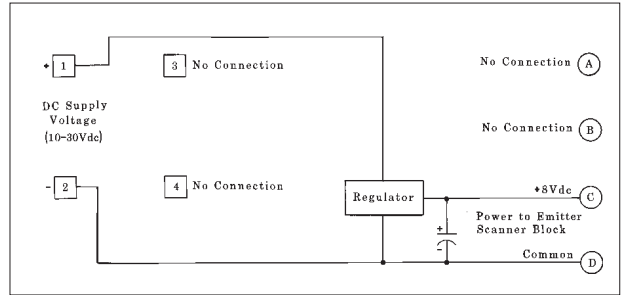
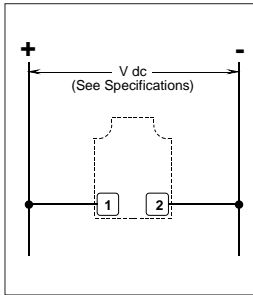

Hookup Diagrams for DC Power Blocks

Output capacity: 250mA maximum, each output.

Hookup to DC Relay or Solenoid (using sinking output)

When using power blocks with current sinking (NPN) outputs, simple loads connect between the power block output (terminal #3) and the positive supply (terminal #1).

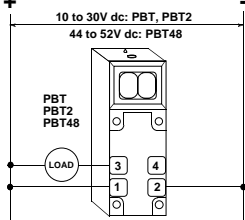

Hookup to DC Relay or Solenoid (using sourcing output)

When using power blocks with current sourcing (PNP) outputs, simple loads connect between the power block output (terminal #3) and dc common (terminal #2).

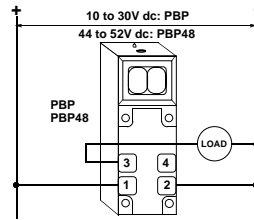

Hookup to Logic Gate

A logic zero (0 volts dc) is applied to the gate input when the MULTI-BEAM output is energized. When de-energized, a logic one is applied. The logic supply must be common to the MULTI-BEAM supply negative.

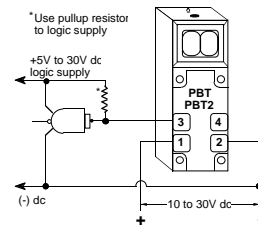

Hookup to a Programmable Controller requiring a current sink

Use power blocks with NPN outputs to interface to PLCs and other logic devices requiring a current sink at the inputs. Connect the output of the power block (terminal #3) to any input of the PLC. Also connect the negative of the MULTI-BEAM power supply (terminal #2) to the negative of the PLC power supply.

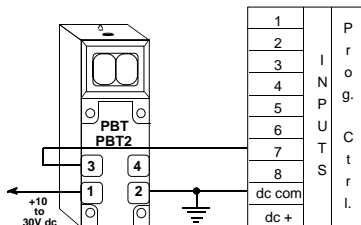

Hookup to a Programmable Controller requiring a current source

Use power blocks with PNP outputs to interface to PLCs and other logic devices requiring a current source at the inputs. Connect the output of the power block (terminal #3) to any input of the PLC. Also connect the negative of the MULTI-BEAM power supply (terminal #2) to the negative of the PLC power supply.

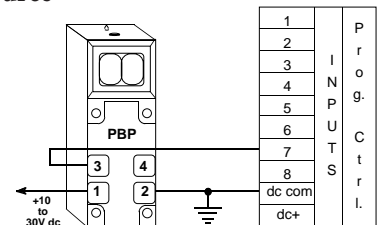

Parallel Hookup to a Common Load

Any number of MULTI-BEAMs may be connected in parallel to one load to create "LIGHT-OR" (light operate mode) or "DARK-OR" (dark operate mode) multiple sensor logic. In most situations, MULTI-BEAM dc power blocks cannot wire in series. However, addition of an interposing relay with a normally closed contact or a Banner logic module will permit "AND" logic with a parallel sensor array.

To load requiring current sink:

To load requiring current source:

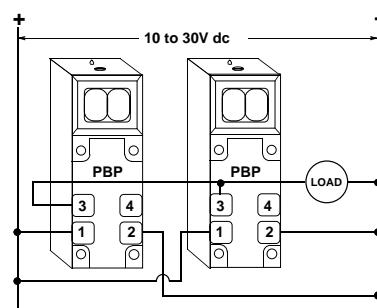
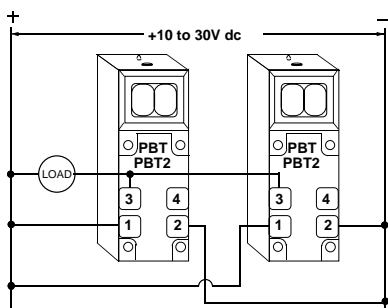

Hookup of DC Emitter

MULTI-BEAM emitter-only scanner blocks use dc power block models PBT-1 or PBT48-1. These power blocks connect directly across the dc supply, as shown.

Emitter models:
SBE
SBED
SBEX
SBEV
SBEXD
SBEF
SBEXF

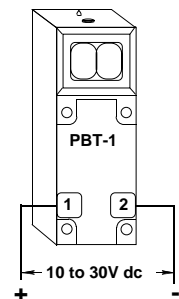

MULTI-BEAM 3- & 4-wire DC Power Blocks

Hookup Diagrams for DC Power Blocks (continued)

Hookup to MAXI-AMP Logic Module

The current sinking output(s) of MULTI-BEAM power block models PBT and PBT2 may be connected directly to the input of CL Series MAXI-AMP modules. A MAXI-AMP which is powered by ac voltage offers a dc supply with enough capacity to power one MULTI-BEAM sensor, as is shown in this hookup diagram. When emitter/receiver pairs are used, the emitter should be powered from a separate power source (e.g.- using PBA-1, etc.)

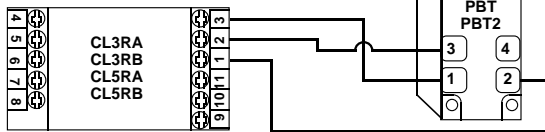

Hookup to B Series Logic Module (MRB Chassis)

The current sinking output(s) of MULTI-BEAM power block models PBT and PBT2 may be connected directly to the input (terminal #5) or the auxiliary input (terminal #3) of any Banner B Series logic module. The MULTI-BEAM is powered by the MRB chassis as shown. Additional logic may be added on a longer chassis. Banner PLUG-LOGIC modules may also be used.

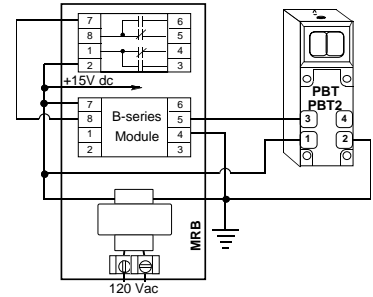

Hookup to MICRO-AMP Logic (MPS-15 Chassis)

The current sinking output(s) of MULTI-BEAM power block models PBT and PBT2 may be connected directly to the primary input (terminal #7) or the other inputs of MICRO-AMP logic modules. The following logic modules may be used:

- MA4-2 One shot
- MA5 On/off delay
- MA4G 4-input "AND"
- MA4L Latch

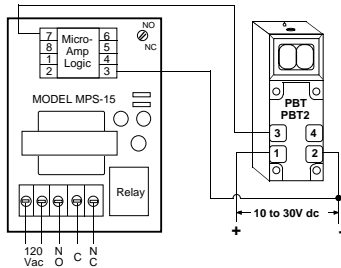

Hookup to Counter

Most counters, totalizers, rate meters, etc., including the battery-powered LCD types, accept the NPN current sinking output of MULTI-BEAM power block models PBT and PBT2 as an input. Counters which are powered by ac line voltage usually offer a low voltage dc supply with enough capacity to power one MULTI-BEAM (≥10V dc at ≥60mA).

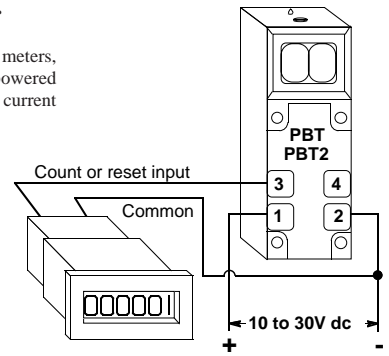

NOTE: MULTI-BEAM dc power blocks cannot be wired in series.

MULTI-BEAM 3- & 4-wire AC Power Blocks

AC Models

Connections

Functional Schematic

PBA **Input:** 105 to 130V ac, 50/60Hz.

PBB **Input:** 210 to 250V ac, 50/60Hz.

PBD **Input:** 22 to 28V ac, 50/60Hz.

PBD-2

Input: 11 to 13V ac, 50/60Hz.

Output: SPST solid-state switch for ac, 3/4 amp maximum (derated to 1/2 amp at 70 degrees C).

Maximum inrush: 10 amps for one second or 30 amps for one ac cycle (non-repeating).

On-state voltage drop: less than 2.5V ac at full load.

Off-state leakage current: less than 100 microamps.

Response: add 8.3 milliseconds to the off-time response of the scanner block.

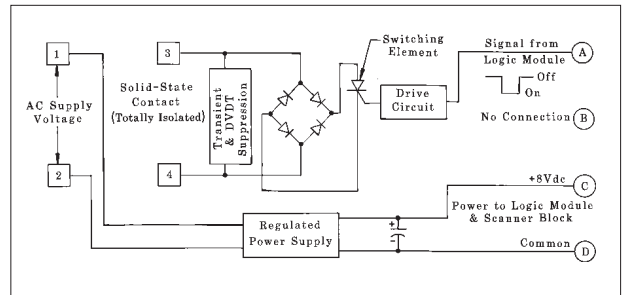
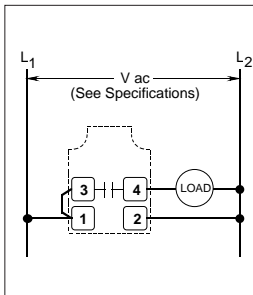

These power blocks are the most commonly used for ac operation. As the typical hookup shows, they are intended to switch the same ac voltage as is used to power the MULTI-BEAM. However, the output of all four blocks is rated for 250V ac maximum, and all can switch a voltage which is different than the supply as long as both ac circuits share a common neutral. For example, a PBA could switch a 24V ac door chime, etc. Observe local codes when mixing ac voltages in a wiring chamber. These blocks are designed to handle the inrush current of ac inductive loads like motor starters and solenoids. The "holding current" specification of any inductive load should not exceed the 750mA output rating. There is no minimum load requirement. These power blocks will interface directly to all ac programmable controller inputs. All contain built-in transient suppression to prevent false turn-on or damage from inductive loads and line "spikes". Outputs of multiple power blocks may be wired in series or parallel for "AND" and "OR" logic functions.

MULTI-BEAM 3- & 4-wire AC Power Blocks

AC Models

Connections

Functional Schematics

PBAT

Input: 105 to 130V ac, 50/60Hz.

Output: SPST isolated solid-state switch; 100mA maximum (no inrush capacity), 200V dc max., 140V ac max.

On-state voltage drop: less than 3 volts at full load.

Off-state leakage current: less than 100 microamps.

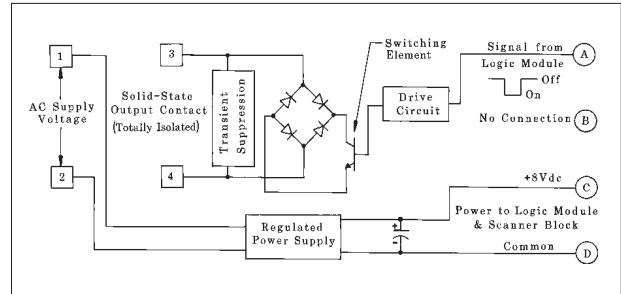
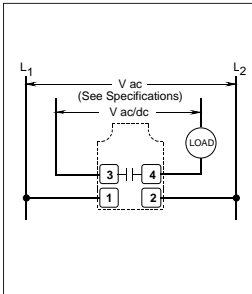

PBBT

Input: 210 to 250V ac, 50/60Hz.

Output: SPST isolated solid-state switch; 100mA maximum (no inrush capacity), 350V dc max., 250V ac max.

On-state voltage drop: less than 3 volts at full load.

Off-state leakage current: less than 100 microamps.

Power block models PBAT and PBBT have an isolated solid-state output switch which may be used to switch either ac or dc. The switch is rated at 100mA maximum, and there is no capacity for inrush. As a result, these power blocks usually should not be used to switch ac inductive loads. However, 100mA is enough capacity to switch many inductive *dc* loads like small relays and solenoids. Models PBAT and PBBT interface directly to all ac programmable controller inputs.

Since the saturation voltage of these power blocks is typically greater than 1 volt, they should *not* be used to interface 5V dc logic circuits like TTL. Instead, use special order model PBOL or PBOBL.

NOTE: add 8.3 milliseconds to the off-time response of the scanner block.

PBO

Input: 105 to 130V ac, 50/60Hz.

PBOB

Input: 210 to 250V ac, 50/60Hz.

Output: SPST isolated optically coupled transistor switch (will switch dc only); 50mA maximum, 30V dc max.

On-state saturation voltage: less than 1 volt at 2mA, less than 1.3 volts at 50mA.

Off-state leakage current: less than 10 microamps.

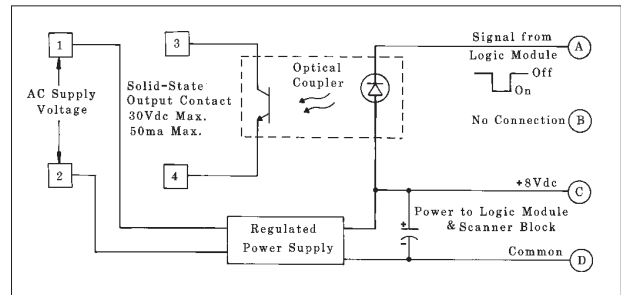
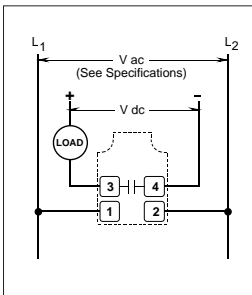

These power blocks are designed to interface an electronic circuit (or control) at a low dc voltage level, but where there is no dc supply voltage available to power the MULTI-BEAM. Since the output is isolated it may be wired to either source or sink current, and multiple units may be wired in either series or parallel. The output of model PBO or PBOB will directly interface Banner component system logic modules. The low on-state saturation voltage allows direct interfacing to most solid-state low voltage dc logic systems or electronic totalizers.

Note: the 1-volt saturation prevents direct interfacing to 5-volt logic systems like TTL. For these low-voltage interfaces, use instead special order power block model PBOL or PBOBL.

PBAM

Input: 105 to 130V ac, 50/60Hz.

Output: 8Vdc at 8mA maximum (short circuit proof).

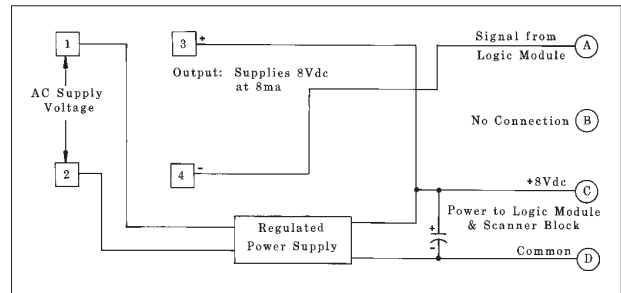
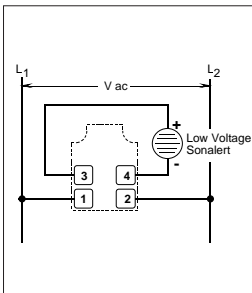

If you are unable to find the power block for your interface, contact the Banner Application Engineering Department during normal business hours at (612) 544-3164.

Model PBAM is a special-purpose power block that is powered by 120V ac, and provides a low level source of dc output voltage when the sensor's output is energized. It is used primarily to power low voltage audio tone annunciators such as "SONALERTS". The PBAM may also provide a signal to many types of logic devices. The output is approximately 8V dc when energized, and the output impedance is 1K ohm (short circuit proof). The output is totally isolated from the ac supply voltage, and may be used to provide an input signal to many line-powered or battery-powered electronic totalizers.

MULTI-BEAM 3- & 4-wire AC Power Blocks

AC Models

Connections

Functional Schematics

PBAQ  

Input: 105 to 130V ac, 50/60Hz.

Output: SPST isolated solid-state switch; normally closed, 3/4 amp maximum (derated to 1/2 amp at 70 degrees C).

Maximum inrush: 10 amps for one second or 30 amps for one ac cycle (non repeating).

On-state voltage drop: less than 2.5V ac at full load.

Off-state leakage current: less than 100 microamps.

Response: add 8.3 milliseconds to the off-time response of the scanner block.

NOTE: the output of the PBAQ will not conduct when power is removed from terminal #1 or 2.

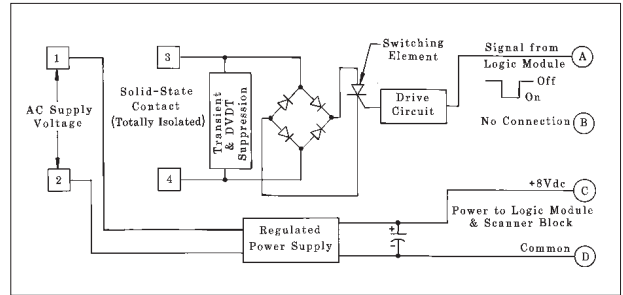
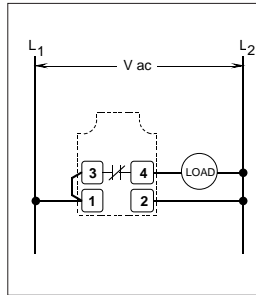

Model PBAQ is identical to model PBA (page 17) except that the solid-state output contact is normally closed instead of normally open. It is used where it is necessary to have the load de-energize when something is sensed (e.g. - one shot pulse to de-energize load). When no timing logic is involved, model LM3 can program any power block for normally open or normally closed operation via the light/dark operate jumper. **NOTE: model PBAQ is not compatible with logic module models LM5 and LM5-14. For normally closed on-delay logic, use PBA with LM5R and reverse the light/dark function.**

These are power blocks for emitter scanner blocks only (models SBE, SBED, SBEX, SBEV, SBEXD, SBEF, SBEXF). Emitter assemblies do not require logic modules.

PBA-1  

Input: 105 to 130V ac, 50/60Hz.

PBB-1  

Input: 210 to 250V ac, 50/60Hz.

PBD-1

Input: 22 to 28V ac, 50/60Hz.

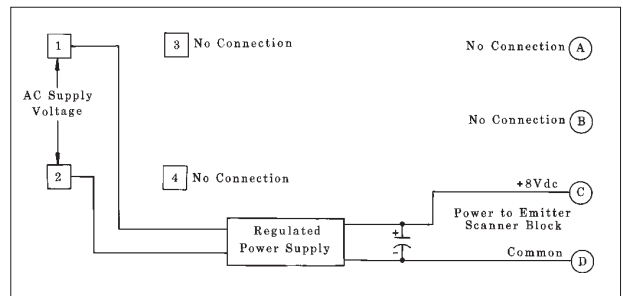
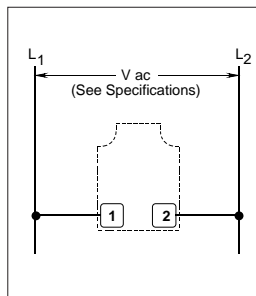

Hookup Diagrams for AC Power Blocks

Hookup to a Simple AC Load

NOTE: output switching capacity is 3/4 amp maximum.

AC voltage is connected to terminals #1 and #2 to provide power to the MULTI-BEAM. The solid-state output switch behaves as if there were a contact between terminals #3 and #4. L1 is most conveniently applied to terminal #3 by jumpering terminals #1 and #3 inside the MULTI-BEAM.

The outputs of all five power block models are rated for 250V ac maximum, and can switch an ac voltage which is different from the supply as long as both ac circuits share a common neutral. Observe local wiring codes when mixing AC voltages in a common wiring chamber.

Since the output switch is a solid-state device, contact continuity cannot be checked by means of an ohmmeter, continuity tester, etc. To check the functioning of the output switch, a load must be installed and tested along with the MULTI-BEAM.

CAUTION: the output switch could be destroyed if the load becomes a short circuit (i.e., if L1 and L2 are connected directly across terminals #3 and #4).

NOTE: this hookup depicts the output switch as a normally open contact. *Model PBAQ actually has a normally closed output switch.*

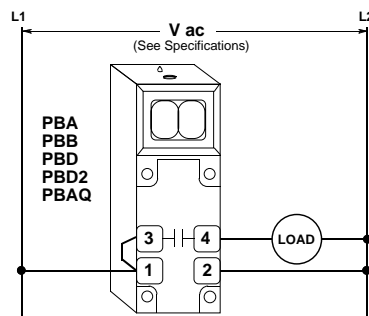

Hookup of an AC Emitter

MULTI-BEAM emitter-only ac power blocks connect directly across the ac line, as shown.

Emitter models: SBE, SBED, SBEX, SBEV, SBEXD, SBEF, and SBEXF.

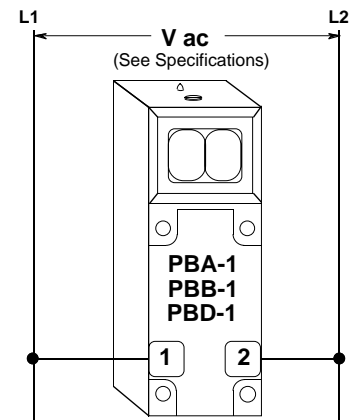

MULTI-BEAM 3- & 4-wire AC Power Blocks

Hookup Diagrams for AC Power Blocks (continued)

Hookup in Parallel with other MULTI-BEAMs

Any number of 3- & 4-wire MULTI-BEAM power block outputs may be connected in parallel to a load. Parallel sensor connection is usually used to yield "OR" logic (i.e., if an event occurs at any sensor, the load is energized). The total off-state leakage current through the load is the sum of the leakage current of the individual power blocks. However, the maximum leakage current of MULTI-BEAM 3- & 4-wire ac power blocks is only 100 microamps. As a result, installation of an artificial load resistor in parallel with the load is necessary only for large numbers of sensors wired in parallel to a light load.

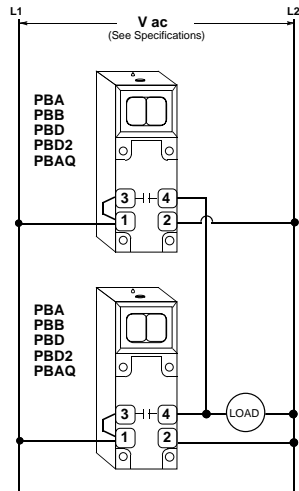

Hookup in Series with other MULTI-BEAMs

MULTI-BEAM 3- & 4-wire ac power blocks may be wired in series with each other for the "AND" logic function. The total voltage drop across the series will be the sum of the individual voltage drops across each power block (approximately 3 volts per block). With most loads, 10 or more power blocks may be wired in series.

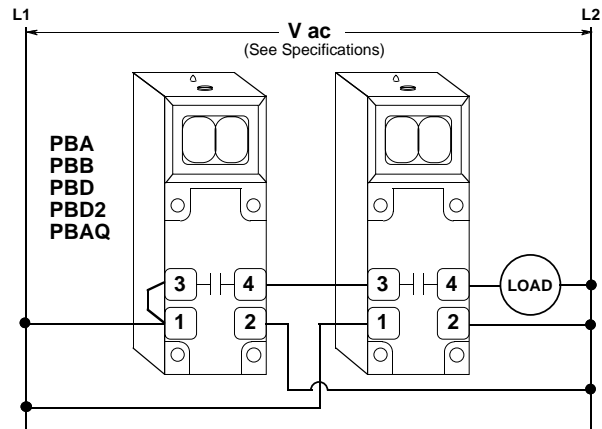

Hookup in Parallel with Contacts or Switches

Any number of "hard" contacts may be wired in parallel with one or more MULTI-BEAM 3- & 4-wire power blocks. All models have less than 100 microamps (0.1 milliamp) of off-state leakage current. The load operates when either the contacts close or the MULTI-BEAM output is energized.

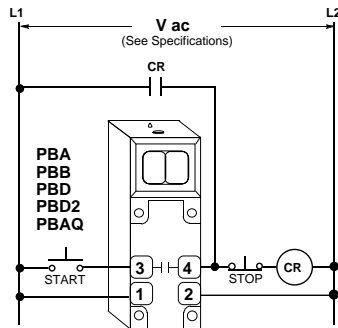

Hookup in Series with Contacts or Switches

Terminals #3 and #4 of MULTI-BEAM 3- & 4-wire power blocks may be connected in series with one or more "hard" contacts. The load operates only when all contacts are closed and the MULTI-BEAM output is energized.

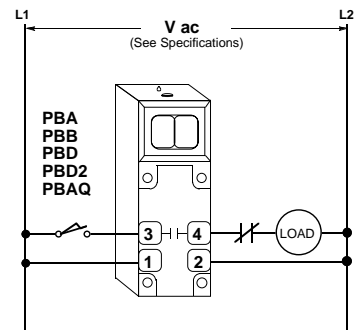

Hookup to a Programmable Logic Controller (PLC)

Interfacing to a PLC I/O is direct with MULTI-BEAM 3- & 4-wire ac power blocks. All models have less than 100 microamps (0.1 milliamp) of off-state leakage current. If you have a question on hookup to a particular brand of PLC, contact the Banner Applications Department during normal business hours.

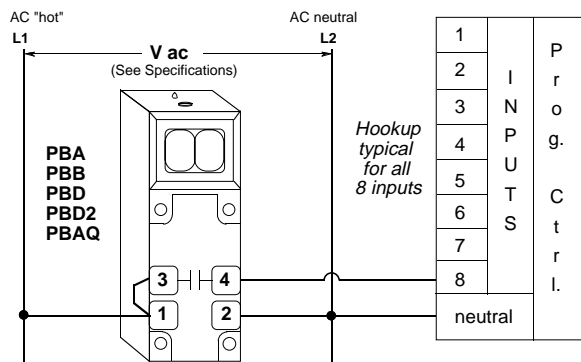

Hookup to a Counter

Power block models PBO and PBOB are designed to power the MULTI-BEAM with ac voltage and to permit the sensor output to interface with low voltage dc circuits and devices. A common situation involves inputting to battery-powered LCD totalizers, rate meters, etc. The output switch is the transistor of an optical coupler, which may be connected to switch dc common to the count input. Polarity must be observed.

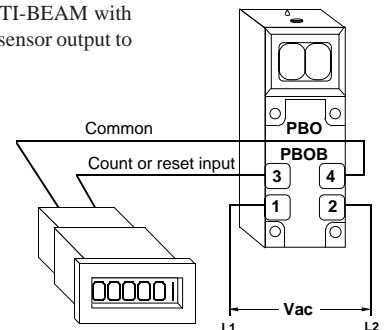

MULTI-BEAM 3- & 4-wire Logic Modules



The logic module interconnects the power block and scanner block both electrically and mechanically using a unique blade-and-socket connector concept. It also provides the LIGHT/DARK operate function (except in the LM1) and the timing functions, all of which are fully adjustable.

In the diagrams below, the "signal" represents the light condition (in LIGHT operate) or the DARK condition (in DARK operate), and the "output" represents the energized condition of the solid-state output switch (power block). "Delay" refers to the time delay before the output operates, and "hold" refers to the time that the output remains "on" after the event has occurred.

The photo (left) shows a typical logic module for 3- or 4-wire operation. Note that all 3- & 4-wire logic modules are color-coded red. The time ranges listed for the logic modules in the table below are standard time ranges. Other time ranges are available; see page 23 for information.

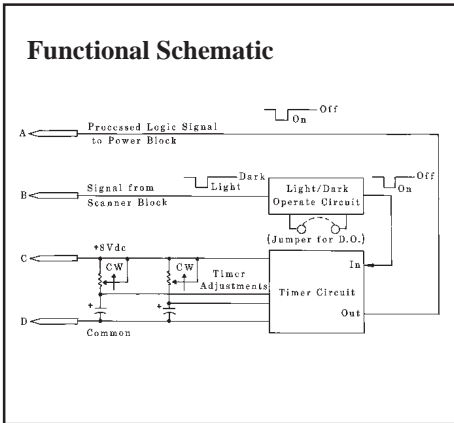

Specifications, 3- and 4-wire Logic Modules

CONSTRUCTION: molded VALOX® housing; electronic components epoxy encapsulated. Gold plated blade connectors.









OPERATING TEMPERATURE: -40 to +70 degrees C (-40 to +158 degrees F).

TIMING ADJUSTMENT(S): one or two single turn potentiometers with slot for blade-type screwdriver adjustment. NOTE: when turning time adjustments fully clockwise or counterclockwise, avoid excessive torque to prevent damage to potentiometers.

TIMING REPEATABILITY: plus or minus 2% of maximum range under constant power supply and temperature conditions; plus or minus 5% of maximum range under all conditions of supply voltage and temperature.

RESPONSE TIME: response time will be that for the scanner block (plus power block) plus the programmed delay (if the logic includes a delay function).

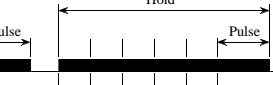
TIMING RANGE: useful range is from maximum time down to 10% of maximum (e.g.- from 1 to 0.1 seconds, or from 15 to 1.5 seconds). When timing potentiometer is set fully counterclockwise, time will be approximately 1% of maximum.

Model and Function	Description of Logic
<p>LM1 on-off</p> <p>OUTPUT </p> <p>SIGNAL </p>	<p>LM1 is an on-off logic module that causes the power block output to "follow the action" of the scanner block: when the scanner block sees a LIGHT signal, the output is energized; when the scanner block sees a DARK signal, the output is de-energized. This is referred to as the LIGHT operate mode. If the application calls for DARK operate mode, the LM1 may be used with normally-closed type power blocks such as PBAQ or PBT2.</p>
<p>LM2 alternate action</p> <p>OUTPUT </p> <p>SIGNAL </p>	<p>The LM2 provides "flip-flop" or toggling action of the power block output, such that each time the scanner block changes from a DARK state to a LIGHT state, the output changes state. The output remains in the last state until another change occurs. The LM2 is frequently used to operate a diverter gate that splits a production line into two lines. It may also be used to operate room lighting by breaking a photoelectric beam: if the lights are OFF, breaking the beam turns them ON; if the lights are ON, breaking the beam turns them OFF.</p>
<p>LM3 on-off</p> <p>OUTPUT </p> <p>SIGNAL </p>	<p>The LM3 is an on-off logic module that has the ability to be programmed for either LIGHT operate or DARK operate. It comes with a jumper wire installed: with the jumper in place, the output is DARK operated; with the jumper removed, the output is LIGHT operated. The LM3 is the most commonly used logic module when no timing function is desired, particularly if it is not known at the time of ordering which mode (LIGHT or DARK operate) will be needed.</p>
<p>LM4-2 one-shot (retriggerable)</p> <p>OUTPUT </p> <p>SIGNAL </p> <p>Setable time range: .1 to 1 second.</p>	<p>The LM4-2 provides a one-shot ("single shot") output pulse each time there is a transition from LIGHT to DARK (jumper installed) or from DARK to LIGHT (jumper removed). The output pulse time range is adjustable from 0.1 to 1 second. The duration of the pulse is independent of the duration of the input signal. The timing of the LM4-2 is restarted each time the input signal is removed and then recurs. This is referred to as a "retriggerable" one shot, and this feature may be applied to some rate sensing applications (use LM6-1 for true rate sensing).</p>

MULTI-BEAM 3- & 4-wire Logic Modules

Model and Function

Description of Logic

LM4-2NR one-shot (non-retriggerable)

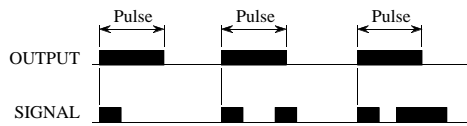

Setable time range: .1 to 1 second.

The **LM4-2NR** provides a one-shot ("single shot") output pulse each time there is a transition from LIGHT to DARK (jumper installed) or from DARK to LIGHT (jumper removed). The output pulse time range is adjustable from 0.1 to 1 second. The duration of the pulse is independent of the duration of the input signal. The output pulse of the LM4-2NR must complete before it recognizes another input transition. This is called a "non-retriggerable" one shot, which sometimes offers an advantage in indexing or registration control applications where multiple input signals are possible during advance of the product.

LM5 on-delay

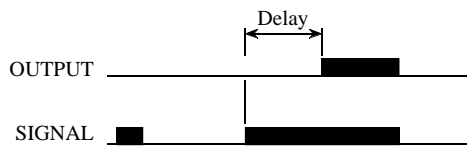

Setable time range: 1.5 to 15 seconds.

The **LM5** is a true "on-delay" type logic module. The input signal must be present for a predetermined length of time before the output is energized. The output then remains energized until the input signal is removed. If the input signal is not present for the predetermined time period, no output occurs. If the input signal is removed momentarily and then reestablished, the timing function starts over again from the beginning. A LIGHT/DARK operation selection jumper is included. The standard time range is adjustable from 1.5 to 15 seconds (field adjustable), and other ranges are available. The LM5 is often used to detect jams on a conveyor line, where a beam broken for longer than a preset period of time implies a product jammed in the light beam.

LM5R off-delay

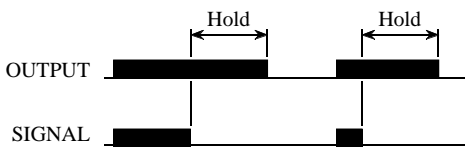

Setable time range: 1.5 to 15 seconds.

The **LM5R** is an "off-delay" logic module, similar to the LM5, except that timing begins on the trailing edge of the input signal. When the input occurs, the output is immediately energized; if the input is then removed, the output remains energized for the adjustable pre-determined time period, then de-energizes. If the input is removed but then re-established while the timing holds the output energized, a new output cycle is begun. The LM5R might typically be used to tell when no products have broken a beam for a predetermined length of time, therefore indicating a jam or an empty reservoir upstream. The LIGHT/DARK operate jumper wire is included. Timing range is adjustable from 1.5 to 15 seconds, and optional ranges are available.

LM5-14 on- & off-delay

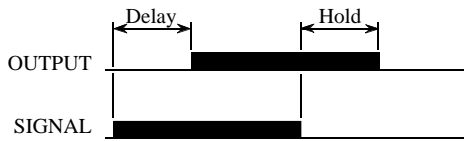

Setable time range: 1.5 to 15 seconds.

The **LM5-14** combines the function of an "on-delay" and an "off-delay" into one logic module. When the signal is present for more than the on-delay time, the output energizes. The off-delay circuit is now active, and holds the output on even if the input signal disappears for short periods of time. If the input signal is gone for longer than the off-delay time, the output finally drops out. The most common use for the LM5-14 is to control fill level, for example in a bin: when the bin is full, a beam is broken, and a predetermined time later, the flow is stopped. After the level has fallen below the beam for a time, the flow is restarted. The time delays control the high and low levels. Each delay is independently adjustable for 1.5 to 15 seconds.

LM5T limit timer

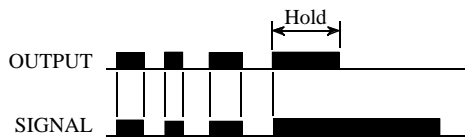

Setable time range: 1.5 to 15 seconds.

The **LM5T** "limit" timer combines the function of on-off logic and on-delay logic. As long as the signal is present for only short periods of time, the output "follows the action" of the input signal. If the input signal is present for longer than the predetermined time, the output deenergizes. The output only reenergizes when the input signal is removed and then reestablished. Interval timers are used to operate loads which must not run continuously for long periods of time, such as intermittent duty solenoids and conveyor motors. The LM5T may be used to run a supermarket checkout conveyor, always bringing the product up to the sensor beam and then stopping the motor. When the last item is removed, the motor times out and stops. Timing range is .15 to 15 seconds.

LM6-1 rate sensor





Setable rate: 60 to 1200 pulses per minute.

The **LM6-1** is a true overspeed or underspeed sensing logic module that monitors signals from a scanner block and continuously calculates the time between input signals, and compares that time with the reference set by the "HOLD" potentiometer. A jumper allows the mode to be changed from *overspeed* (jumper installed) to *underspeed* (jumper removed). In the overspeed mode, the output will drop if the preset rate is exceeded. In the underspeed mode, the output remains energized until the input rate drops below the preset. The output will not "pulse" at low speeds as retriggerable one-shots do. A "DELAY" adjustment allows the LM6-1 to ignore data for the first several seconds after power is applied, to permit the rate to accelerate to operating speed without false underspeed outputs. The sensing rate may be adjusted from 60 to 1200 pulses per minute (.05 to 1.0 second per pulse), and the power-up inhibit from 1 to 15 seconds.

MULTI-BEAM 3- & 4-wire Logic Modules

Model and Function

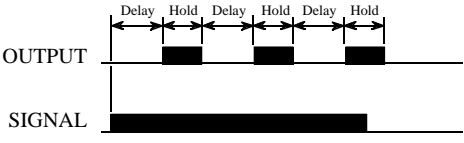
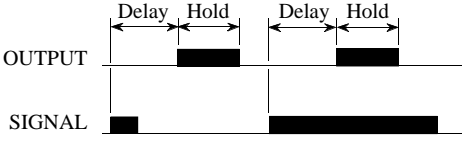
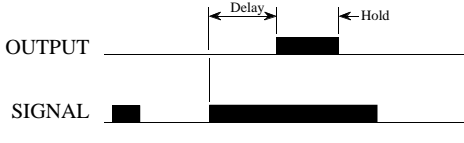
Description of Logic

<p>LM8 repeat cycler</p>  <p>Setable time range: 1.5 to 15 seconds.</p>	<p>The LM8 is a repeat cycle timing module with independently adjustable delay and hold times. When an input signal is received from the scanner block, a delay period begins during which there is no output. If the signal remains, the delay period is followed by a hold period, during which the output is energized. If the signal still remains, the hold period times out, releasing the output and starting a new delay period. This sequence continues indefinitely until the input signal is removed. The LM8 is used in edgeguide and other registration control schemes where it is desired to "pulse" the correction motor to avoid overcorrection that might occur with a continuous output. Both time ranges are independently adjustable from 1.5 to 15 seconds. NOTE: use of the LIGHT/DARK operate jumper is reversed: remove for DARK, leave in place for LIGHT.</p>
<p>LM8-1 delayed one-shot</p>  <p>Setable time range: 1.5 to 15 seconds.</p>	<p>The LM8-1 is a delayed one-shot that functions very much like two individual one-shots, with the end of the first initiating the second. When an input signal occurs, a delay period is initiated, during which time the output is not energized. After the delay, the output is energized for the hold period, then deenergized. No further action takes place unless the signal is removed and then reestablished. This sequence is independent of the duration of the input signal. The LM8-1 is frequently used to sense a product, and then act on that product a short time later when it is clear of the inspection station. An example might be to inspect cartons for open flaps, and to eject the faulty cartons when they have completely passed the inspection point. Both time ranges are adjustable from 1.5 to 15 seconds.</p>
<p>LM8A on-delay one-shot</p>  <p>Setable time range: 1.5 to 15 seconds.</p>	<p>The LM8A differs slightly from the LM8-1. It too incorporates both a delay and a hold time, except that the delay is a true on-delay. If the input signal does not last for the total duration of the delay time, no output action ever occurs (with the LM8-1, even a momentary signal generates one complete cycle of timing). If the delay time passes, the one-shot output occurs, regardless of what happens to the input signal. Removing the input signal and reapplying it begins a new cycle. The LM8A is used to eject a part that has remained in the sensor beam longer than the delay time (for instance, a jammed part). Both time ranges are independently adjustable from 1.5 to 15 seconds. NOTE: use of the LIGHT/DARK operate jumper is reversed: remove for DARK, leave in place for LIGHT.</p>
<p>LM10 ÷10 counter</p> 	<p>The LM10 is a fixed-count divide-by-ten logic module, with neither timing nor LIGHT/DARK operate functions. When power is first applied, the output is OFF; with each dark-to-light transition, the LM10 enters one count in its memory. After five counts, the output is energized, and it remains energized until the tenth count. It then deenergizes, and the sequence continues. The LM10 is intended for product counting applications using programmable logic controllers or computers, where the scan time of the input section of the controller is too slow to permit "catching" high speed count rates. It may also be used with electromechanical totalizers, which suffer from this same slow response. In operation, of course, the registered count must be multiplied by ten to get the true count (ambiguity of five).</p>
<p>LMT test logic</p> 	<p>LMT is a plug-in test logic module for use when troubleshooting MULTI-BEAM sensors. It contains LED indicator lights in place of the timing potentiometers and a miniature switch in place of the LIGHT/DARK operate jumper. The indicator lights display the operation of the scanner block and power block to verify proper functioning, and the switch permits manual operation of the load to verify the output switching circuit. The step-by-step testing procedure included with the LMT will allow a MULTI-BEAM to be completely tested without removing it from the installation, and, if there is a faulty scanner block, power block, or logic module, the LMT will identify it. <i>The LMT may also be used with all 2-wire MULTI-BEAMS (see pages 24 to 29).</i></p>

Logic Module Modifications

The time ranges of any MULTI-BEAM 3- & 4-wire logic module may be factory modified. Time range modification is often necessary to improve the setability of the timing function. Some time range modifications are carried in stock. The current Banner products price list is the best source of this information. Other time range modifications may be quoted. When ordering modified logic modules, add the letter "M" after the model number, followed by the maximum time desired (in seconds). **The table below lists possible modifications.**

Model Number Suffix	Setable Time Range
M.01	.001 to .01 seconds
M.1	.01 to .1 seconds
M.5	.05 to .5 seconds
M1	.1 to 1 second
M5	.5 to 5 seconds
M15	1.5 to 15 seconds

- For logic modules with a single timing function, specify the maximum desired time in seconds (e.g., LM5M5 indicates an LM5 on-delay with the delay time adjustable up to 5 seconds).

- For logic modules with dual timing functions, specify the maximum desired delay and hold time in seconds (e.g., LM5-14M1M5 indicates an LM5-14 on-off delay with an on-delay adjustable up to 1 second and an off-delay adjustable up to 5 seconds). Always specify both timing ranges, even if only one is to be modified.

- For fixed timing, the letter "F" should always be followed by the desired time, in seconds (e.g., LM5MF1 would be an LM5 on-delay with a fixed 1 second delay time). For fractions of seconds, use decimal equivalents, such as LM5MF.5, or LM5MF.01, etc.

MULTI-BEAM 2-wire Sensors

2-wire MULTI-BEAM

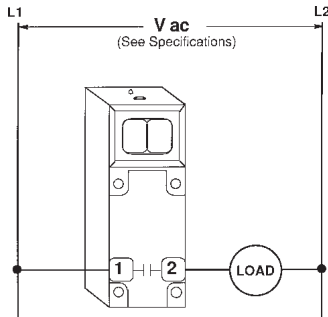

The components of the MULTI-BEAM 2-wire family of modular self-contained sensors are physically identical to the 3- & 4-wire components. However, the 2-wire components are designed to wire directly in series with an ac load, exactly like a limit switch. This design makes the 2-wire MULTI-BEAM impossible to wire backward.

MULTI-BEAM 2-wire scanner blocks with their 10 millisecond response time have approximately the same optical performance as the 1-millisecond 3- & 4-wire scanner block models.

The off-state leakage current of 2-wire MULTI-BEAM sensors is less than 1 milliamp, the lowest value of any 2-wire photoelectric sensor. This makes the MULTI-BEAM 2-wire photoelectric device the most probable such device to interface directly with ac inputs of programmable logic controllers (PLCs).

Functional Schematic, 2-wire MULTI-BEAM

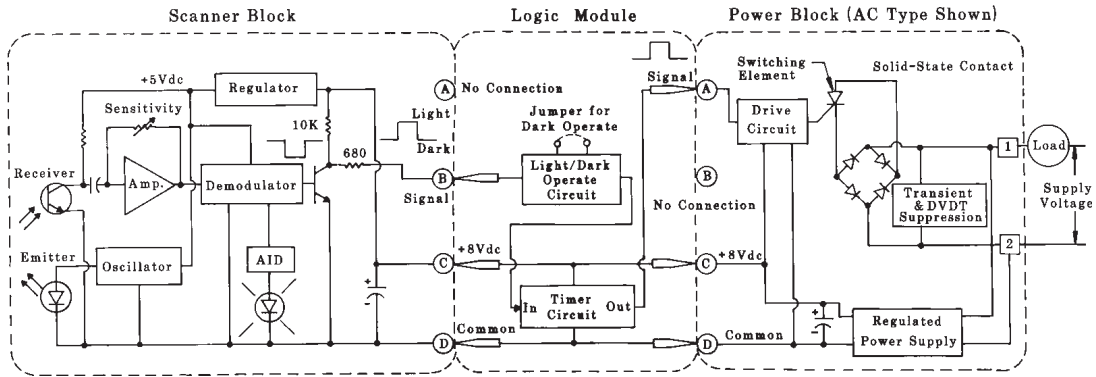

MULTI-BEAM 2-Wire Scanner Blocks

SPECIFICATIONS

SUPPLY VOLTAGE: connections are made via a 2-wire power block (see page 27).

RESPONSE TIME: 10 milliseconds ON and OFF (3000 operations per minute). NOTE: a built-in false pulse protection circuit holds the output off for 100 milliseconds after power is initially applied to the sensor.

REPEATABILITY OF RESPONSE: see individual sensor specs.

SENSITIVITY ADJUSTMENT: easily accessible, located on top of scanner block beneath o-ring gasketed screw cover. 15-turn clutched control (rotate clockwise with a small screwdriver to increase gain).

ALIGNMENT INDICATOR: red LED on top of scanner block. Banner's exclusive, patented Alignment Indicating Device (AID™) circuit lights the LED whenever the sensor detects its own modulated light source, and pulses the LED at a rate proportional to the received light level.

CONSTRUCTION: reinforced VALOX® housing with components totally encapsulated. Stainless steel hardware. Meets NEMA standards 1, 3, 12, and 13.

OPERATING TEMPERATURE RANGE: -40 to +70 degrees C (-40 to +158 degrees F).

Functional Schematic, 2-wire Scanner Block

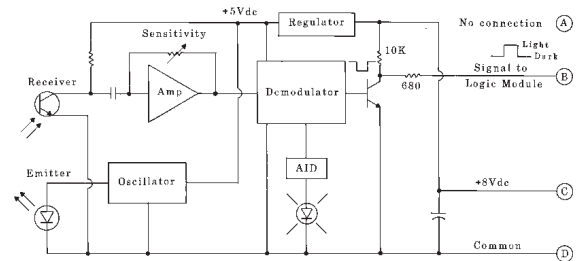

Dimension Drawing, 2-wire Scanner Block

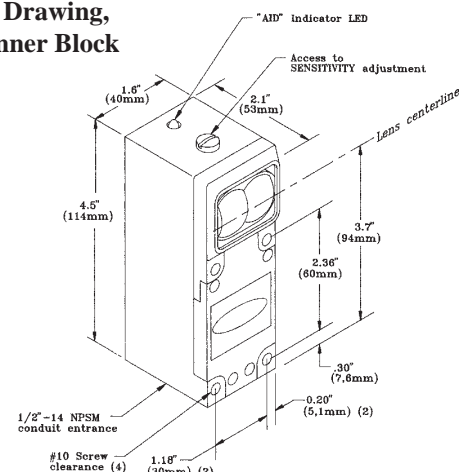

MULTI-BEAM 2-wire Scanner Blocks

Sensing Mode

Models

Excess Gain

Beam Pattern

OPPOSED Mode

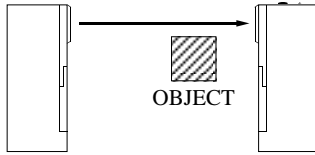

SBE & 2SBR1

Range: 150 feet (45m)
Response: 10ms on/off
Repeatability: 0.03ms
Beam: infrared, 940nm
Effective beam: 1" dia.

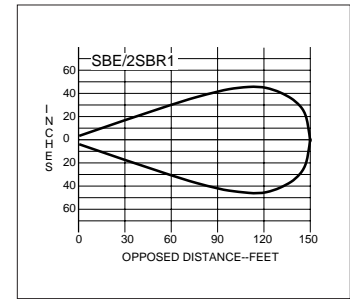
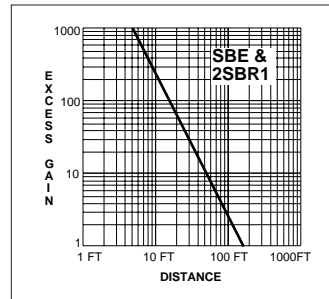

Model 2SBR1 receiver is used with the SBE emitter, which is the same emitter used with the 1 millisecond 3- & 4-wire receiver model SBR1. The response time, however, is determined by the receiver, and is 10 milliseconds. This pair will work reliably in slightly dirty (average manufacturing plant) conditions up to 60 feet opposed, and outdoors up to 20 feet. When more distance (or excess gain) is required, use 3- & 4-wire receiver model SBRX1 with the SBEX emitter. The 2SBR1 will not work with the visible emitter SBEV. Use opposed mode sensors as a first choice in any application, except where the material to be sensed is translucent to light or so small that it will not break the effective beam diameter. The SBE emitter uses a 3 & 4 wire power block. Powerblocks for use with SBE include models PBA-1, PBB-1, PBD-1, PBT-1, and PBT48-1 (see pages 16 and 19 for information on these powerblocks).

RETROREFLECTIVE

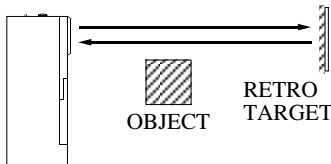

2SBL1

Range: 1 in. to 30 feet
 (2.5cm to 9m)
Response: 10ms on/off
Repeatability: 2.5ms
Beam: infrared, 940nm

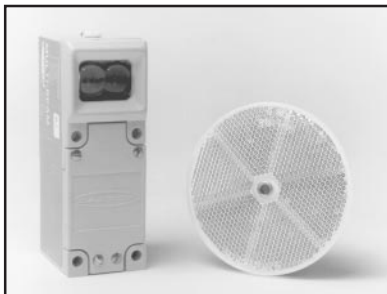
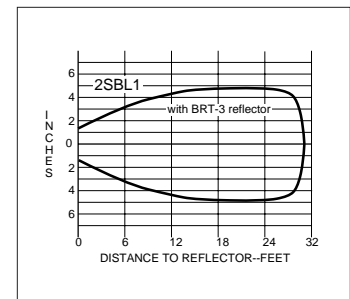
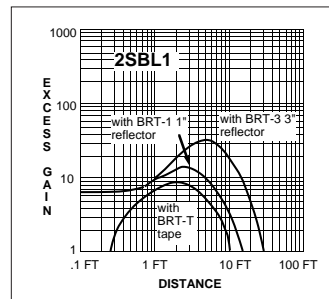

Model 2SBL1 is the retroreflective mode scanner block in the 2-wire MULTI-BEAM family. It has the same excellent optical performance as model SBL1 in the 3- & 4-wire family. If the application calls for breaking a retroreflective beam with shiny objects such as metal cans or cellophane-wrapped packages, mount the 2SBL1 and its retroreflector at an angle of 10 degrees or more to the shiny surface to eliminate any direct reflections from the object itself, or consider using 3- & 4-wire scanner block model SBLVAG1 (page 8). Alternatively, the MAXI-BEAM, VALU-BEAM, and MINI-BEAM families offer 2-wire ac visible and polarized retroreflective models. Notice from the excess gain curve that the gain falls off at very close sensing ranges, so much so that retroreflectors cannot be used reliably closer than one inch from the sensor.

CONVERGENT Mode

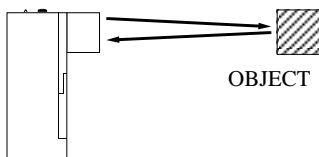

2SBC1

Focus at: 1.5inches
 (38mm)

2SBC1-4

Focus at: 4 inches
 (10cm)
Response: 10ms on/off
Repeatability: 2.5ms
Beam: infrared, 940nm

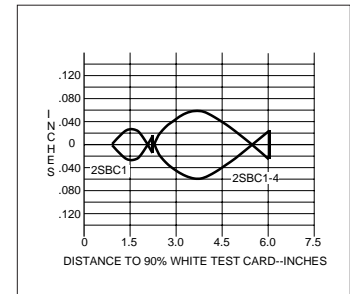
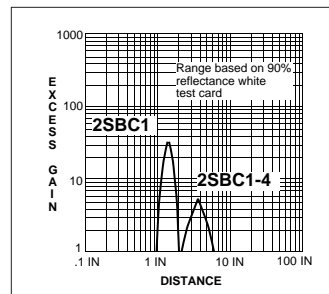

These convergent mode 2-wire scanner blocks are identical in performance to their 3- & 4-wire equivalents, except for the 10 millisecond response time. They are designed for 2-wire applications where background objects might be seen by proximity mode sensors, or where the precision of a small focused image is important (e.g. - edge-guiding or position control). Model 2SBC1 provides much more excess gain at its focus point as compared to the diffuse mode sensors. Convergent mode sensors are preferable to diffuse mode sensors if the distance from the sensor to the object to be detected can be kept constant. Models 2SBC1 and 2SBC1-4 may be derived from retro model 2SBL1 by exchange of the upper cover assembly. Model 2SBC1 uses upper cover UC-C, and model 2SBC1-4 uses upper cover model UC-C4. These may be interchanged. A 6-inch convergent model may be created from either model by substituting upper cover UC-C6. See the Upper Cover Interchangeability Chart in the Banner product catalog for more information.

MULTI-BEAM 2-wire Scanner Blocks

Sensing Mode

Models

Excess Gain

Beam Pattern



2SBD1

Range: 12 inches (30cm)
Response: 10ms on/off
Repeatability: 2.5ms
Beam: infrared, 880nm

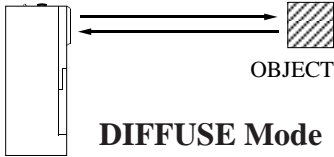
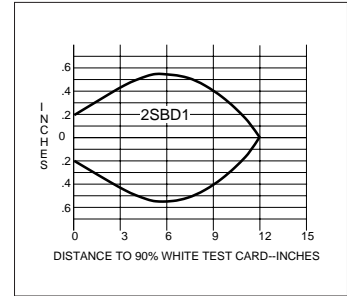
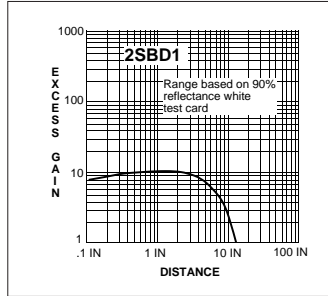

Models **2SBD1** and **2SBDX1** diffuse (proximity) mode scanner blocks are identical except for their lenses. Model **2SBD1** uses upper cover model UC-D, and the **2SBDX1** uses UC-L (see MULTI-BEAM Accessories, pages 30-31). While the UC-L lens extends the range to over 30 inches, it creates a "dip" in the excess gain at closer ranges. As a result, the **2SBDX1** may sense a dark colored object at 10 inches, but it may not see it at all at 2 inches. If the application is not completely defined, either scanner block may be ordered, along with the complementary upper cover as an accessory.



2SBDX1

Range: 30 inches (76cm)
Response: 10ms on/off
Repeatability: 2.5ms
Beam: infrared, 880nm

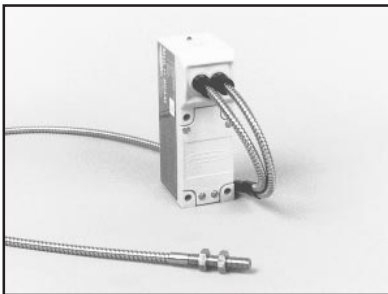
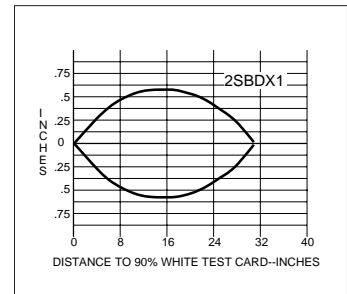
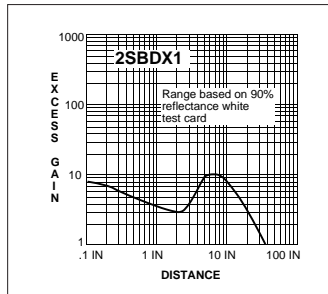

2SBF1

Range: see E.G. curves
Response: 10ms on/off
Repeatability: 2.5ms
Beam: infrared, 880nm

Scanner block **2SBF1** combines the simplicity of 2-wire hookup with the sophistication and versatility of optical fibers. The infrared source of this model will work with any Banner glass fiber optic assembly, except bifurcated assemblies with bundle diameters less than 1/16". Since fibers are frequently used for sensing small parts, fast response time is often a consideration. If the application requires response near the 10 millisecond specification of the **2SBF1**, consider the faster 3- & 4-wire model **SBF1**.

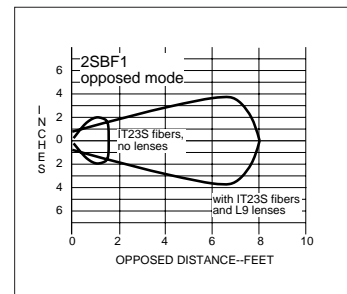
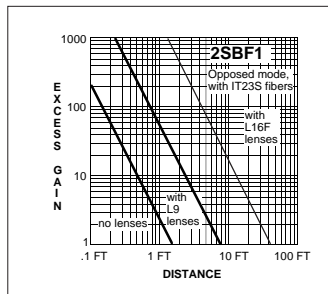

FIBER OPTIC Mode (glass fibers)

OPPOSED MODE

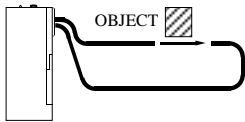

RETROREFLECTIVE MODE

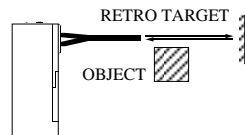

DIFFUSE MODE

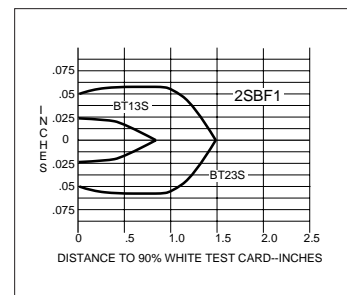
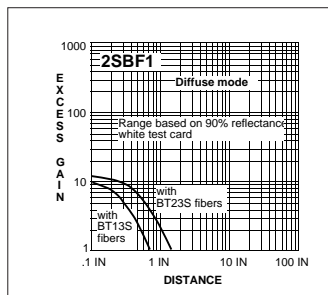
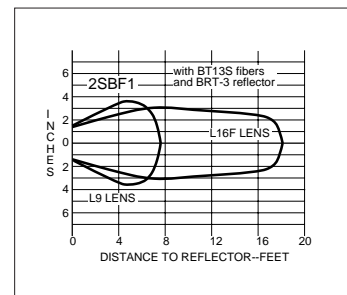
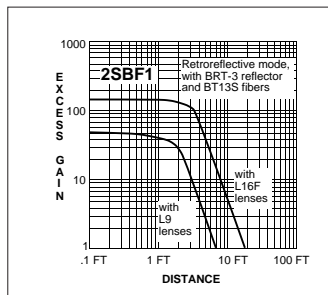
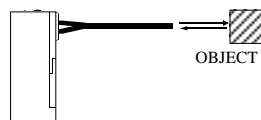

For complete information on glass fiber optic assemblies, see the Banner product catalog.

MULTI-BEAM 2-wire Power Blocks



MULTI-BEAM 2-wire power block models 2PBA, 2PBB, and 2PBD contain a low voltage power supply which utilizes a unique circuit to take a very small leakage current through the load and convert it to the dc power required to run the scanner block and logic module. They also contain the solid-state switch that operates the load, and a transient suppression circuit to prevent false operation from high voltage spikes on the incoming line. They are completely solid-state for unlimited operating life.

Model 2PBR is a 4-wire power block which works with 2-wire scanner blocks and logic modules and offers an SPST "hard" contact for switching heavy ac or dc loads. Model 2PBR2, also for use with 2-wire scanner blocks and logic modules, uses a 3- or 4-wire hookup with SPDT "hard" contacts for switching heavy ac loads.

NOTE: MULTI-BEAM 2-wire ac power blocks are color-coded black.

Models

Connections

Functional Schematics

2PBA listed certified

Operating voltage: 105 to 130V ac, 50/60Hz

2PBB listed certified

Operating voltage: 210 to 250V ac, 50/60Hz

2PBD

Operating voltage: 22 to 28V ac, 50/60Hz

Output: SPST solid-state switch, 3/4 amp maximum (derated to 1/2 amp at 70 degrees C).

Maximum inrush: 10 amps for 1 second (non-repeating).

On-state voltage drop: less than 10 volts

Leakage current: less than 1 milliamp (resistive or inductive loads)

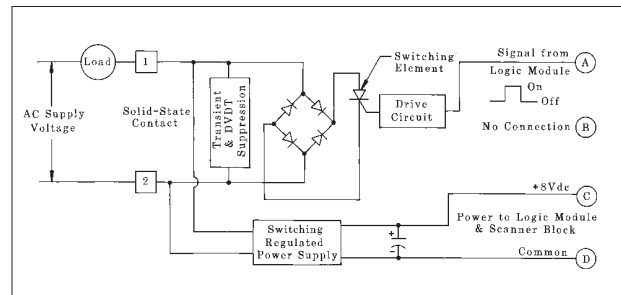
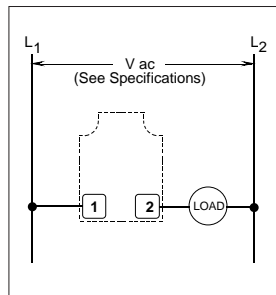

MULTI-BEAM 2-wire power blocks offer the ultimate in simplicity of sensor hookup. They wire directly in series with an ac load, exactly like a limit switch. Response time of 2-wire power blocks is determined by the scanner block, which is 10 milliseconds on/off. A built-in false pulse protection circuit holds the output OFF for 100 milliseconds after power is initially applied to the power block. 2-wire power blocks will operate from -40 to +70 degrees C (-40 to +158 degrees F). Resistive loads must be less than 15,000 ohms and inductive loads must be greater than 1.2 watts (10 milliamps).

2PBR (Electromechanical relay output)

Input: 105 to 130V ac, 50/60Hz

Output: SPST electromechanical relay contact.

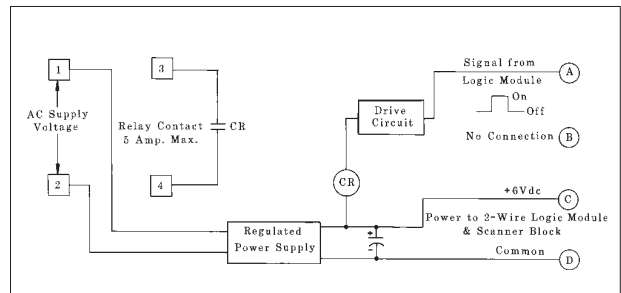
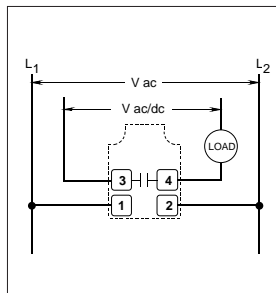

2PBR2 (Electromechanical relay output)

Input: 105 to 130V ac, 50/60Hz

Output: SPDT electromechanical relay contacts, both contacts common to terminal #1 (L1).

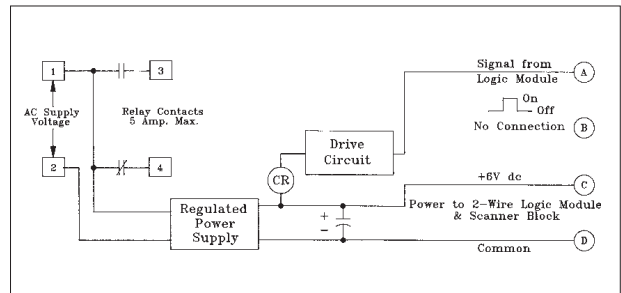
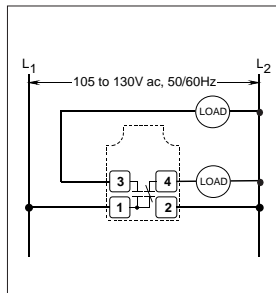

Additional specifications, both models:

Contact rating: 250V ac max, 30V dc max, 5 amps max. (resistive load); install MOV across contact if switching an ac inductive load.

Closure time: 20 milliseconds

Release time: 20 milliseconds

Maximum switching speed: 20 operations/second

Mechanical life of relay: 10,000,000 operations

Model 2PBR actually requires a 4-wire hookup and model 2PBR2 requires a 3- or 4-wire hookup, even though they only work with 2-wire scanner blocks and logic modules. Both are powered by 120V ac across terminals #1 and 2. The **2PBR** offers an SPST "hard" relay contact between terminals #3 and 4. Model **2PBR2** is an SPDT version, with both contacts common to terminal #1: terminal #3 is a normally open output, and terminal #4 is normally closed. These configurations allow MULTI-BEAM sensors to directly interface large loads which draw more than 3/4 amp like clutches, brakes, large contactors, and small motors. **Model 2PBR can switch both ac and dc loads; model 2PBR2 switches the ac line voltage to an ac load** (see connection diagrams). The 2PBR and 2PBR2 also eliminate the problem of voltage drop from series strings of sensors operating low voltage ac loads. NOTE: install an appropriate value MOV (metal oxide varistor) transient suppressor across the power block relay contacts when switching an ac inductive device.

MULTI-BEAM 2-wire Power Blocks

Hookup Diagrams for 2-wire Power Blocks (except models 2PBR & 2PBR2; see page 27)

NOTE: output has maximum load capacity of 3/4 amp; maximum resistive load 15K ohms, minimum inductive load 1.2 watts (10mA)

Basic Hookup of 2-wire MULTI-BEAM

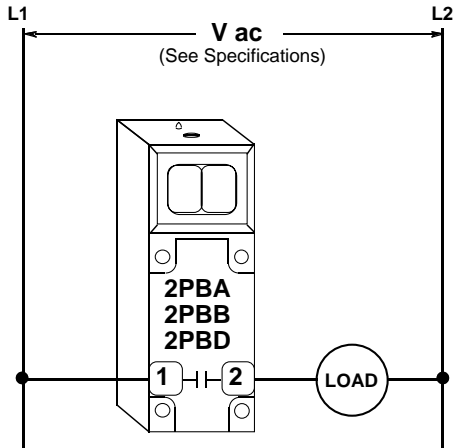

MULTI-BEAM 2-wire sensors wire in series with an appropriate load. This combination, in turn, wires directly across the ac line. A 2-wire sensor may be connected exactly like a mechanical limit switch.

The MULTI-BEAM remains powered when the load is "off" by a residual current which flows through the load. This off-state leakage current is always less than 1 milliamp. The effect of this leakage current depends upon the characteristics of the load. The voltage which appears across the load in the off-state is equal to the leakage current of the sensor multiplied by the resistance of the load:

$$V(\text{off}) = 1\text{mA} \times R(\text{load})$$

If this resultant off-state voltage is less than the guaranteed turn-off voltage of the load, the interface is direct. If the off-state voltage causes the load to stay "on", an artificial load resistor must be connected in parallel with the load to lower its effective resistance. Most loads, including most programmable logic controller (PLC) inputs, will interface to 2-wire sensors with 1mA leakage current without the need for an artificial load resistor. There is no polarity requirement. Either wire may connect to terminal #1, and the other to terminal #2.

CAUTION: all three components of a MULTI-BEAM 2-wire sensor will be destroyed if the load becomes a short circuit!!

2-wire MULTI-BEAMs in Parallel

Multiple 2-wire MULTI-BEAMs may be wired together in parallel to a load for "OR" or "NAND" logic functions. When sensors are wired in parallel, the off-state leakage current through the load is equal to the sum of the leakage currents of the individual sensors. Consequently, loads with high resistance, like small relays and electronic circuits, may require artificial load resistors.

2-wire MULTI-BEAM sensors have a 100 millisecond power-up delay for protection against false outputs. When 2-wire MULTI-BEAMs are wired together in parallel, any power block which has an energized output will rob all of the other power blocks of the current they need to operate. When the energized output drops, there will be a 0.1 second delay before any other MULTI-BEAM can energize. As a result, the load may momentarily drop out.

2-wire MULTI-BEAM sensors cannot wire in series with other 2-wire sensors unless power block model 2PBR is used. If series connection of 2-wire ac sensors is required, consider models within the VALU-BEAM or MINI-BEAM families.

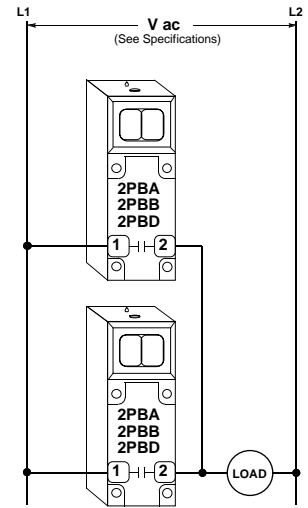

2-wire MULTI-BEAM in Series with Contacts

When 2-wire MULTI-BEAM sensors are connected in series with mechanical switch or relay contacts, the sensor will receive power to operate only when all of the contacts are closed. The false-pulse protection circuit of the MULTI-BEAM will cause a 0.1 second delay between the time that the last contact closes and the time that the load can energize.

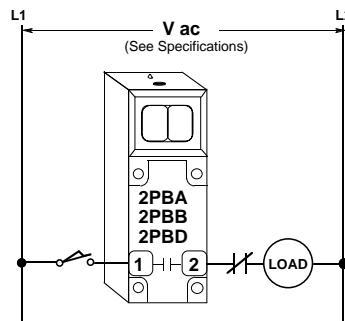

2-wire MULTI-BEAM in Parallel with Contacts

2-wire MULTI-BEAM sensors may be wired in parallel with mechanical switch or relay contacts. The load will energize when any of the contacts close or the sensor output is energized. When a contact is closed, it shunts the operating current away from the MULTI-BEAM. As a result, when all of the contacts are open, the MULTI-BEAM's 0.1 second power-up delay may cause a momentary drop-out of the load.

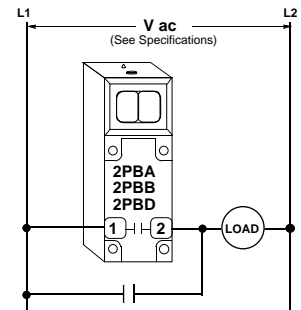

Hookup of 2-wire MULTI-BEAM to a Programmable Logic Controller (PLC)

MULTI-BEAM 2-wire sensors operate with very low (1 milliamp) off-state leakage current. As a result, they will interface directly to most PLCs without the need for an artificial load resistor. If the off-state voltage (1mA x input resistance of the PLC) is higher than the PLC sensing threshold, install a 10KΩ to 15KΩ, 5-watt resistor for each 2-wire sensor. The resistor connects between the input terminal and ac neutral.

If you have a question on hookup to a specific brand of PLC, contact the Banner Applications Department during normal business hours.

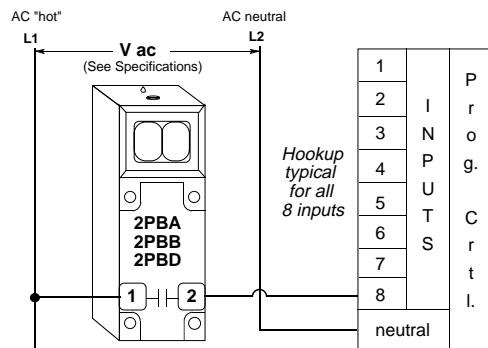

Photoelectric Latch with Manual Reset

1CR relay will latch "on" whenever the 2-wire MULTI-BEAM output is energized. 1CR is reset when the normally-closed pushbutton switch is pressed.

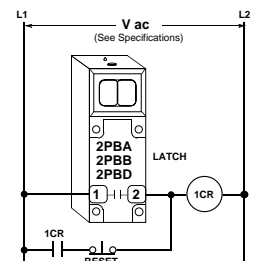

MULTI-BEAM 2-wire Logic Modules

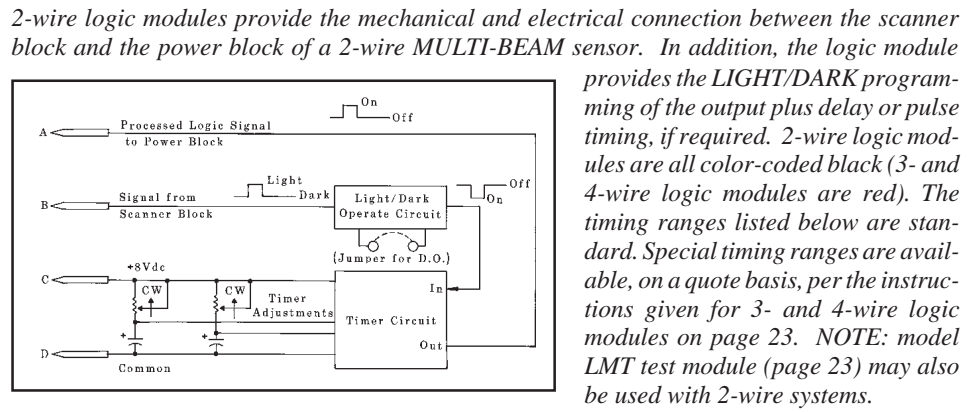

SPECIFICATIONS, 2-WIRE LOGIC MODULES:

specifications for 2-wire logic modules are identical to those for 3- and 4-wire logic modules (see page 21).

Model and Function	Description of Logic
<p>2LM3 on-off</p> <p>OUTPUT</p> <p>SIGNAL</p>	<p>The 2LM3 is an on/off logic module that has the ability to be programmed for either LIGHT or DARK operate. It comes with a jumper wire installed: with the jumper in place, the output is DARK operated; with the jumper removed, the output is LIGHT operated. The 2LM3 is used when no timing function is desired.</p>
<p>2LM4-2 one-shot</p> <p>OUTPUT</p> <p>SIGNAL</p> <p>Setable time range: .1 to 1 second.</p>	<p>The 2LM4-2 provides a one-shot ("single shot") output pulse each time there is a transition from LIGHT to DARK (jumper installed) or from DARK to LIGHT (jumper removed). The output pulse time range is from adjustable from 0.1 to 1 second. The duration of the pulse is independent of the duration of the input signal. The timing of the 2LM4-2 is restarted each time the input signal is removed and then recurs. This is referred to as a "retriggerable" one shot, and this feature may be applied to some rate sensing applications.</p>
<p>2LM5 on-delay</p> <p>OUTPUT</p> <p>SIGNAL</p> <p>Setable time range: 1.5 to 15 seconds.</p>	<p>The 2LM5 is a true "on-delay" type logic module. The input signal must be present for a predetermined length of time before the output is energized. The output then remains energized until the input signal is removed. If the input signal is not present for the predetermined time period, no output occurs. If the input signal is removed momentarily and then reestablished, the timing function starts over again from the beginning. The standard time range is adjustable from 1.5 to 15 seconds, and other ranges are available.</p>
<p>2LM5R off-delay</p> <p>OUTPUT</p> <p>SIGNAL</p> <p>Setable time range: 1.5 to 15 seconds.</p>	<p>The 2LM5R is an "off-delay" logic module, similar to the 2LM5, except that timing begins on the trailing edge of the input signal. When the input occurs, the output is immediately energized; if the input is then removed, the output remains energized for the adjustable predetermined time period, then deenergizes. If the input is removed but then reestablished while the timing holds the output energized, a new output cycle is begun. The LIGHT/DARK operate jumper wire option is included. Timing range is adjustable from 1.5 to 15 seconds, and op-tional ranges are available.</p>
<p>2LM5-14 on- and off-delay</p> <p>OUTPUT</p> <p>SIGNAL</p> <p>Setable time range: 1.5 to 15 seconds.</p>	<p>The 2LM5-14 combines the function of an "on-delay" and an "off-delay" into one logic module. When the signal is present for more than the output on-delay time, the output energizes. The off delay circuit is now active, and holds the output on even if the input signal disappears for short periods of time. If the input signal is gone for longer than the off-delay time, the output finally drops out. The time delays can control high and low levels in flow control applications. Each delay is independently adjustable for 1.5 to 15 seconds.</p>
<p>2LM5T limit timer</p> <p>OUTPUT</p> <p>SIGNAL</p> <p>Setable time range: 1.5 to 15 seconds.</p>	<p>The 2LM5T "limit" timer combines the function of on-off logic and on-delay logic. As long as the signal is present for only short periods of time, the output "follows the action" of the input signal. If the input signal is present for longer than the predetermined time, the output deenergizes. The output only reenergizes when the input signal is removed and then reestablished. Interval timers are used to operate loads which must not run continuously for long periods of time, such as intermittent duty solenoids and conveyor motors. Timing range is adjustable from 1.5 to 15 seconds.</p>

MULTI-BEAM Accessories

Upper Covers (Lens Assemblies)

An upper cover consists of the optical element for the MULTI-BEAM which is built into a gasketed cover for the upper portion of the scanner block. Upper covers may be ordered as replacement parts or for modifying the optical response of a particular model scanner block. The following upper cover assemblies are standard and stocked. Other special variations may be quoted. Stainless steel hardware is included with each cover. NOTE: See the *MULTI-BEAM Accessories* section of the Banner product catalog for information on interchangeability of upper covers between various scanner block models.

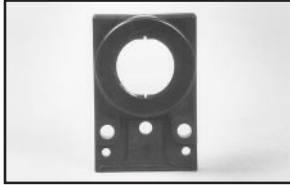

UC-C 1.5 inch (38mm) focus, glass lenses
UC-C4 4 inch (10cm) focus, glass lenses
UC-C6 6 inch (15cm) focus, glass lenses

UC-D

Used on:
 SBD1
 SBED
 SBRD1
 SBEXD
 SBRXD1
 2SBD1



Flat vinyl lens
 for short range and/or wide beam angle.

UC-DMB

(Used on
 SBDX1MD)



"MB" = Modified with Baffle; for short-range proximity mode with SBDX1.

UC-F

(Used on:
 SBF1,
 SBF1MHS,
 SBFX1,
 SBFV1,
 2SBF1).

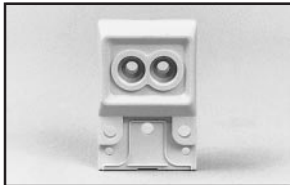

Fits all Banner fiberoptic assemblies.

UC-EF

Used on:
 SBFEF
 SBEXF

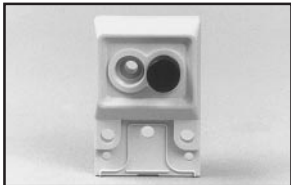

For fiberoptic emitter-only scanner blocks.

UC-RF

Used on:
 SBRF1
 SBRXF1
 SBAR1GHF

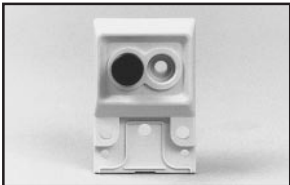

For fiberoptic receiver-only scanner blocks.

UC-L

Used on:
 SBE
 SBEV
 SBEX
 SBR1
 SBRX1
 SBL1
 SBLV1, SBLX1, SBDL1, SBDX1, SBAR1,
 SBAR1GH, 2SBR1, 2SBL1, 2SBDX1,
 3GA5-14, EM3T-1M, R1T3



UC-LAG

(Used on
 SBLVAG1)



Anti-glare (polarizing) filter for retroreflective sensing of shiny objects.

Special Upper Covers

These upper covers are used in special sensing environments.

UC-DJ



Identical to UC-D, but with addition of plastic dust cover to prevent accumulation of dust/dirt in lens area.

UC-LJ



Adds plastic dust cover to UC-L. Used when sensor is mounted facing up (used to prevent dust/dirt buildup on lens).

UC-LG



Replaces UC-L in sensing locations where highly caustic materials are present (e.g. acid vapor or splash). Glass lens.

Lower Covers

Replacement lower covers fit all MULTI-BEAM scanner blocks. Lower covers include gaskets and four stainless steel mounting screws.

LCMB



Standard replacement cover for all scanner blocks.

LCMBMTA



"MTA" = Modified Timing Access. Gasketed nylon screw covers for logic module timing adjustments.

MULTI-BEAM Accessories

Mounting Brackets

Model **SMB700** (right) is a general-purpose two-axis mounting bracket that is supplied with a cable gland assembly which is used to attach the MULTI-BEAM wiring base to the bracket. The gland assembly is threaded through the bracket and into the conduit entrance at the base of the scanner block. A large lockwasher is supplied to hold the scanner block firmly in place. The bracket is 11-gauge zinc plated steel.

Model **SMB700SS** is an 11-gauge stainless steel version of the SMB700. It is sold alone, without the cable gland assembly and lockwasher.

Model **SMB700F** (photo, below) is a flat, single-axis version of the SMB-700. It is sold without hardware.

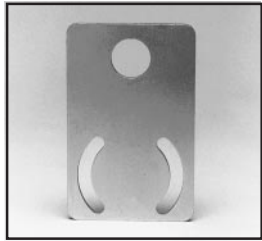

SMB700

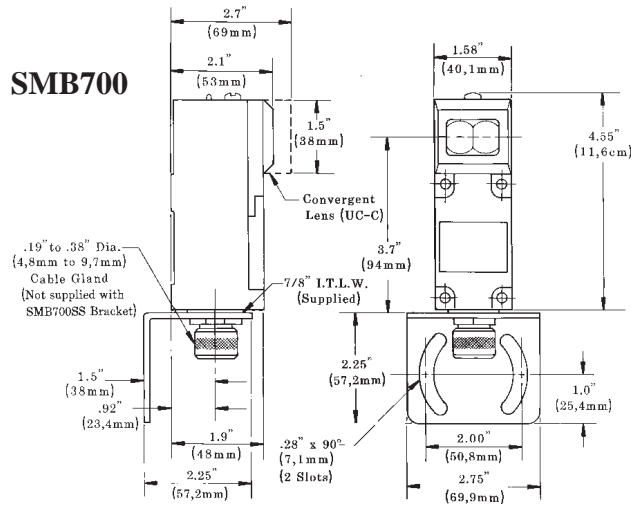

SMBLS

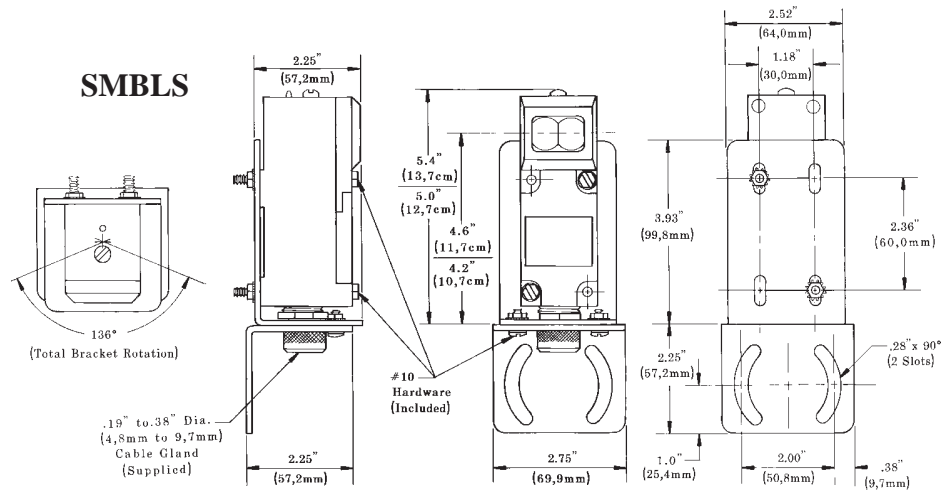

Model **SMBLS** (right) is a two-part bracket assembly which allows adjustment in three directions. It consists of two 11-gauge zinc plated steel right-angle brackets which fasten together so that they rotate relative to each other. The MULTI-BEAM wiring base attaches to the upper bracket and slots are provided for vertical adjustment. The bottom bracket is a modified version of the SMB700. Assembly hardware and a cable gland are included.

SMB700M



Heavy-duty 1/4-inch (6mm) zinc plated steel bracket that allows the MULTI-BEAM to retrofit to installations of MICRO-SWITCH models MLS8 or MLS9 sensors. Includes cable gland and lockwasher.

SMB700P



Heavy duty 1/4-inch (6mm) zinc plated steel bracket that allows the MULTI-BEAM to retrofit to installations of PHOTOSWITCH series 42RLU and 42RLP sensors. Includes cable gland and lockwasher.

RF1-2NPS



Cable gland assembly for MULTI-BEAMS. Includes cord grips for .1 to .4 inch diameter cable. Bracket lockwasher is also included.

MBC-4

MBCC-412

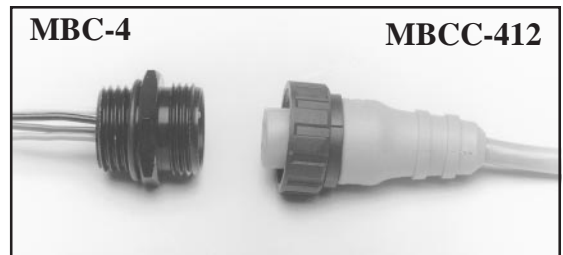

MBC-4 is a 4-pin male industrial-duty connector that threads into the base of all MULTI-BEAMS. **MBCC-412** is a 12-foot long (3.6m) "SJT" type cable. It is interchangeable with standard industry types of several different manufacturers.



WARNING The photoelectric presence sensors described in this catalog do NOT include the self-checking redundant circuitry necessary to allow their use in personnel safety applications. A sensor failure or malfunction can result in *either* an energized or a de-energized sensor output condition.

Never use these products as sensing devices for personnel protection. Their use as a safety device may create an unsafe condition which could lead to serious injury or death.

Only MACHINE-GUARD and PERIMETER-GUARD Systems, and other systems so designated, are designed to meet OSHA and ANSI machine safety standards for point-of-operation guarding devices. No other Banner sensors or controls are designed to meet these standards, and they must NOT be used as sensing devices for personnel protection.

WARRANTY: Banner Engineering Corporation warrants its products to be free from defects for one year. Banner Engineering Corporation will repair or replace, free of charge, any product of its manufacture found to be defective at the time it is returned to the factory during the warranty period. This warranty does not cover damage or liability for the improper application of Banner products. This warranty is in lieu of any other warranty either expressed or implied.