

Features

- Efficiency up to 97%, Non isolated, no need for heatsinks
- Pin-out compatible with LM78XX Linear
- Very low profile (L*W*H=11.5*7.5*10.2)
- Wide input range. (4.75V ~ 34V)
- Short circuit protection, Thermal shutdown
- Non standard outputs available as specials
- Low ripple and noise
- UL94V-0 Package Material
- EMC Certified
- See Positive-to-Negative Converter Application Note for use as a voltage inverter (alternative to LM79xx Linear)

Rev. 1

Description

The R-78xx-Series high efficiency switching regulators are ideally suited to replace 78xx linear regulators and are pin compatible. The efficiency of up to 97% means that very little energy is wasted as heat so there is no need for any heat sinks with their additional space and mounting costs. Low ripple and noise figures and short circuit, overload and over-temperature protection round off the specifications of this versatile converter series.

This R-78xx-0.5 is fully certified to EN 60601-1-2 (Medical Equipment), EN 55022 (Emissions), and EN55024 (Immunity) EMC Standards.

Selection Guide

Part Number SIP3	Input Range (1) (V)	Output Voltage (V)	Output Current (A)	Efficiency	
				Min. Vin (%)	Max. Vin (%)
R-781.5-0.5	4.75 – 30	1.5	0.5	73	63
R-781.8-0.5	4.75 – 34	1.8	0.5	82	71
R-782.5-0.5	4.75 – 34	2.5	0.5	87	77
R-783.3-0.5	4.75 – 34	3.3	0.5	91	81
R-785.0-0.5	6.5 – 34	5.0	0.5	94	86
R-786.5-0.5	8.0 – 34	6.5	0.5	95	88
R-789.0-0.5	11 – 34	9.0	0.5	96	92
R-7812-0.5	15 – 34	12	0.5	97	94
R-7815-0.5	18 – 34	15	0.5	97	95

Note 1: 1.5V Output can be unstable with $V_{in} > 30VDC$

Standard Application Circuit

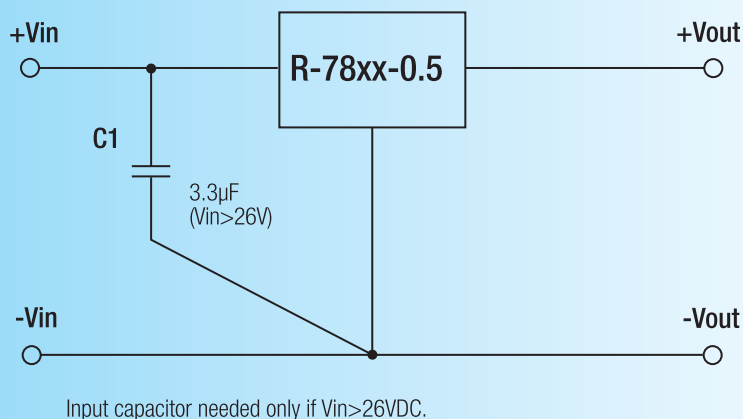

INNOLINE
DC/DC-Converter

R-78xx-0.5 Series

0.5 AMP SIP3 Single Output

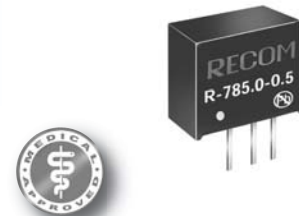

EN-55022 Certified
EN-55024 Certified
EN-60601-1-2 Certified

RECOM

Derating-Graph (Ambient Temperature)

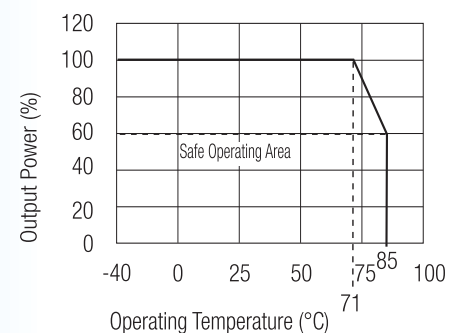

Specifications (typical at 25°C, 10% minimum load, unless otherwise specified)

Characteristics	Conditions	Min.	Typ.	Max.
Input Voltage Range	1.5V	4.75		30.0V
	1.8V to 15.5V	4.75		34.0V
Output Voltage Range (for customized parts)	All Series	1.25		15.5V
Output Current (see note)	All Series	0*		500mA
Output Current Limit	All Series			2000mA
Short Circuit Input Current (Vin = 24V)	All Series			60mA
Internal Power Dissipation				0.4W
Short Circuit Protection			Continuous, automatic recovery	
Output Voltage Accuracy (At 100% Load)	All Series		±2	±3%
Line Voltage Regulation (Vin = min. to max. at full load)	1.5V to 6.5V		0.2	0.4%
	9V to 15.5V		0.1	0.2%
Load Regulation (10 to 100% full load)	1.5V to 6.5V		0.4	0.6%
	9V to 15.5V		0.25	0.4%
Dynamic Load Stability	100% <-> 50% load		±75mV	
	100% <-> 10% load			±100mV
Ripple & Noise (without Output Capacitor)	1.5V to 6.5V		20mVp-p	30mVp-p
	9V to 15.5V		30mVp-p	40mVp-p
Ripple & Noise (with Output Capacitor=100µF)	1.5V to 6.5V		15mVp-p	20mVp-p
	9V to 15.5V		25mVp-p	35mVp-p
Temperature Coefficient	-40°C ~ +85°C ambient			0.015%/°C
Max capacitance Load				220µF
Switching Frequency		280	330	380kHz
Quiescent Current	Vin = min. to max. at 0% load		5	7mA
Operating Temperature Range		-40°C		+85°C
Operating Case Temperature				+100°C
Storage Temperature Range		-55°C		+125°C
Case Thermal Impedance				70°C / W
Thermal Shutdown	Internal IC junction			+160°C
Conducted Emissions	EN55022			Class B
Radiated Emissions	EN55022			Class B
ESD	EN61000-4-2			Class A
Radiated Immunity	EN61000-4-3			Class A
Fast Transient	EN61000-4-4			Class A
Conducted Immunity	EN61000-4-6			Class A
Magnetic Field Immunity	EN61000-4-8			Class A
Package Weight				1.9g
MTBF (+25°C) (+71°C)	} Detailed Information see Application Notes chapter "MTBF"	using MIL-HDBK 217F		21098 x 10 ³ hours
		using MIL-HDBK 217F		4212 x 10 ³ hours

*Note: Operation under no load will not damage these devices, however they may not meet all specifications. A minimum load of 6mA is recommended

Application Examples

High efficiency, isolated, dual unregulated outputs

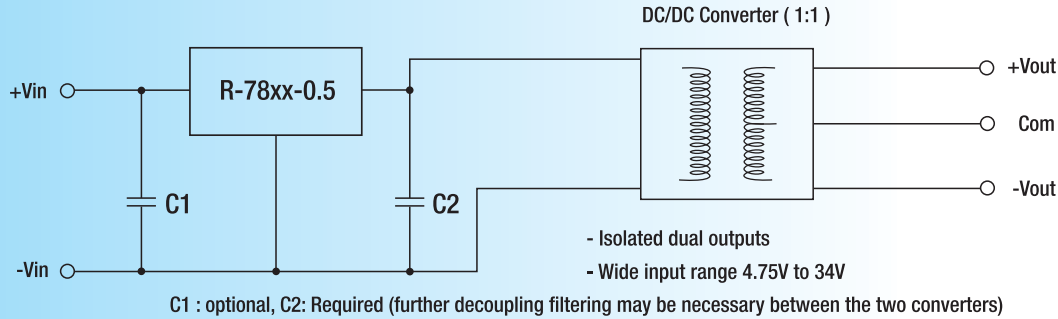

Isolated (up to 6KV), wide Input range regulated output

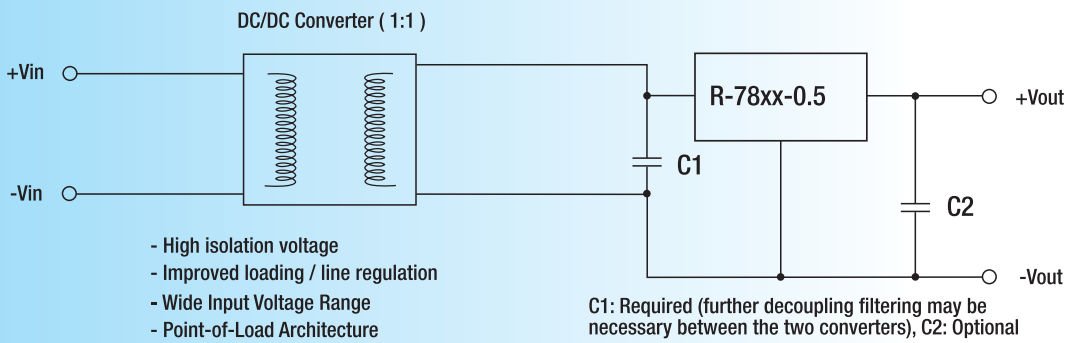

Package Style and Pinning (mm)

SIP3 PIN Package

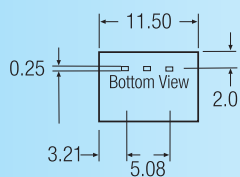
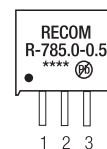
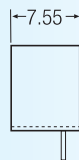
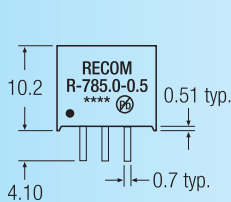

Recommended Footprint Details

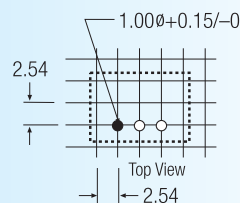

Pin Connections

Pin #	Connection
1	+Vin
2	GND
3	+Vout

xx.x ±0.5mm
xx.xx ±0.25mm