

Revision level/ Indice		Revision Record désignation	Changed	Date	Approved	Date
Part Pièce	Drawing Dessin					

A (2:1)

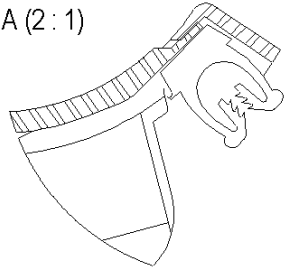

A-A

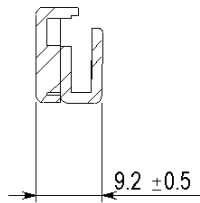

142 ± 1

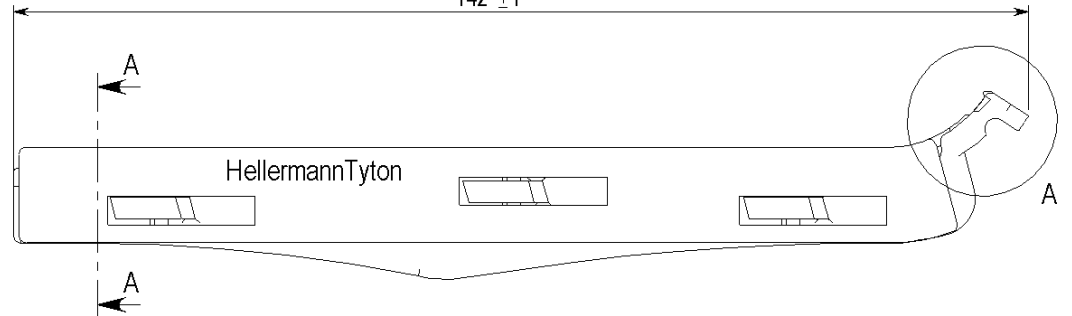

HellermannTyton

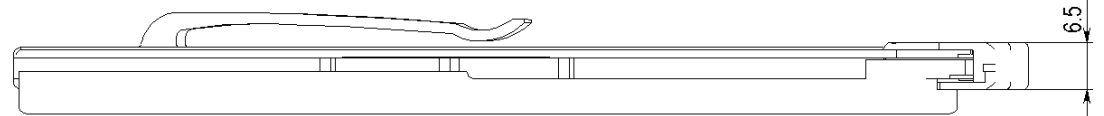
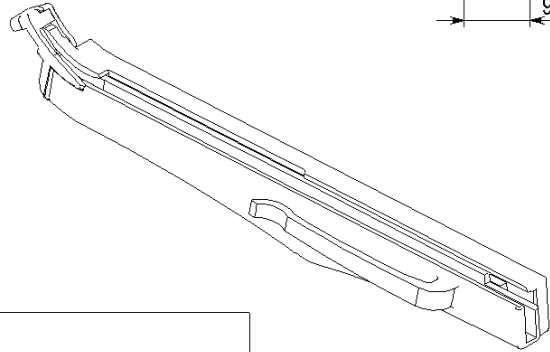

6.5 ± 0.5

TOOL FOR WIC RANGE :
 WIC 1 { 20 parts loaded }
 WIC 2 { 20 parts loaded }
 WIC 3 { 10 parts loaded }

Material: PA 6 G.F. 15%
 Matière: BLACK / NOIR

Dimension without tolerances
 Cotes non tolérancées
 details to:

DIN 16901 /

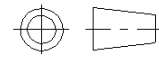
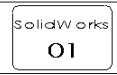

Drawn Dessiné par	P.Cherdo	04/04/03
Approved Approuvé par	M.Rodriguez	04/04/03

Scale:
Echelle: 1/1

Title
Titre
**Wire Identification Cable - WIC
Hand tool for WIC pose**

Tolerances
PERFORMANCE
SPECIFICATION

The copyright of this drawing is reserved
 by HELLERMANN France.
 It is issued on condition that it is not
 reproduced, copied or disclosed to a
 third party, either wholly or in part, without
 the consent of HELLERMANN France.

La propriété de ce plan est réservée
 à la société Hellermann France.
 Il est distribué à condition qu'il ne soit
 pas reproduit, communiqué ou révélé
 à une tierce partie, soit complètement
 ou en partie, sans le consentement de
 la société Hellermann France.

HellermannTyton

Tel: 01.30.13.80.00
 Fax: 01.30.13.80.60

Drawing-No
Plan-N°: **WICTOOL**
 UNS NUMBER: 561 00001

Format
A4
 Sheet 1 of 1
 page