

# LED and Photosensor Pair

## Types OPS690, OPS691, OPS692, OPS693

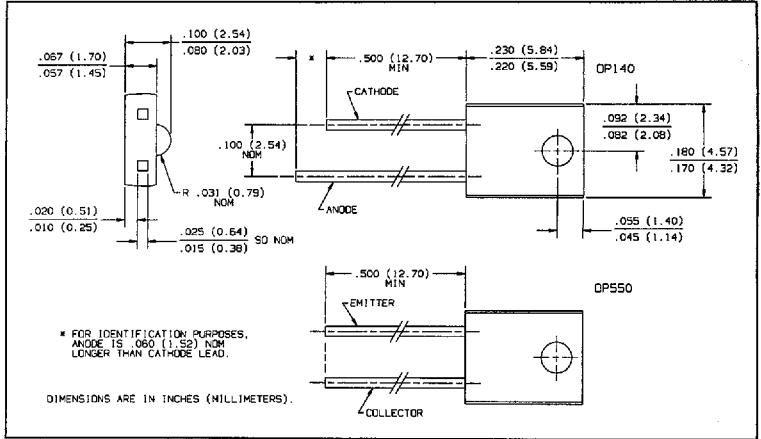
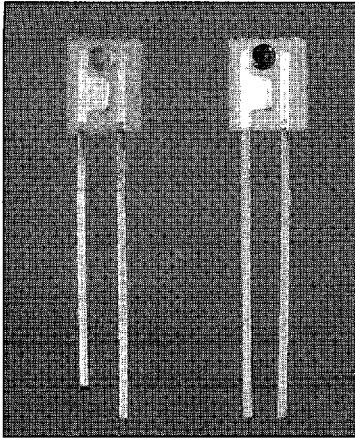

### Features

- Lateral side-looking clear plastic package
- High current transfer ratio
- Low cost plastic package

### Description

The OPS690 through OPS693 each consist of a gallium arsenide infrared emitting diode (OP140) and an NPN silicon phototransistor (OP550) mounted in matched lateral side-looking plastic packages. Matched pairs are desirable where the application is unique and the quantity required does not justify assembly tooling costs. If separation between the LED and the sensor is greater than two times the specified  $I_{C(ON)}$  distance, proper alignment becomes critical. It should be remembered that the sensor is sensitive to ambient light. Although sold as pairs, emitters are packaged separately from sensors for ease of handling.

### Absolute Maximum Ratings ( $T_A = 25^\circ\text{C}$ unless otherwise noted)

Storage and Operating Temperature . . . . .  $-40^\circ\text{C}$  to  $+100^\circ\text{C}$   
 Lead Soldering Temperature [1/16 inch (1.6 mm) from case for 5 sec. with soldering iron] . . . . .  $260^\circ\text{C}$  <sup>(1)</sup>

#### Input Diode

Continuous Forward Current . . . . . 50 mA  
 Peak Forward Current (1  $\mu\text{s}$  pulse width, 300 pps) . . . . . 3.0 A  
 Reverse Voltage . . . . . 2.0 V  
 Power Dissipation . . . . . 100 mW <sup>(2)</sup>

#### Output Phototransistor

Collector-Emitter Voltage . . . . . 30 V  
 Emitter-Collector Voltage . . . . . 5.0 V  
 Power Dissipation . . . . . 100 mW <sup>(2)</sup>

#### Notes:

- (1) RMA flux is recommended. Duration can be extended to 10 sec. max when flow soldering. Max. 20 grams force may be applied to leads when soldering.
- (2) Derate linearly 1.33 mW/ $^\circ\text{C}$  above  $25^\circ\text{C}$ .
- (3) Distance from lens tip to lens tip is 0.125 inches (3.18 mm).

6798580 0002703 0T8

# Types OPS690, OPS691, OPS692, OPS693

Electrical Characteristics ( $T_A = 25^\circ\text{C}$  unless otherwise noted)

SYMBOL	PARAMETER	MIN	TYP	MAX	UNITS	TEST CONDITIONS
<b>Input Diode</b>						
$V_F$	Forward Voltage			1.60	V	$I_F = 20\text{ mA}$
$I_R$	Reverse Current			100	$\mu\text{A}$	$V_R = 2.0\text{ V}$
<b>Output Phototransistor</b>						
$V_{(BR)CEO}$	Collector-Emitter Breakdown Voltage	30			V	$I_C = 100\ \mu\text{A}$ , $E_e = 0$
$V_{(BR)ECO}$	Emitter-Collector Breakdown Voltage	5.0			V	$I_E = 100\ \mu\text{A}$ , $E_e = 0$
$I_{CEO}$	Dark Current			100	nA	$V_{CE} = 10\text{ V}$ , $E_e = 0$
<b>Coupled</b>						
$V_{CE(SAT)}$	Saturation Voltage			0.40	V	$I_F = 20\text{ mA}$ , $I_C = 50\ \mu\text{A}^{(3)}$
$I_{C(ON)}$	On-State Collector Current	OPS690 OPS691 OPS692 OPS693	100 500 1.0 2.0		$\mu\text{A}$ $\mu\text{A}$ mA mA	$V_{CE} = 10\text{ V}$ , $I_F = 20\text{ mA}^{(3)}$

## Typical Performance Curves

**Coupling Characteristics of OP140 and OP550**

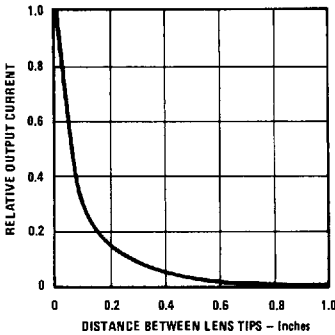

**Forward Current vs Forward Voltage**

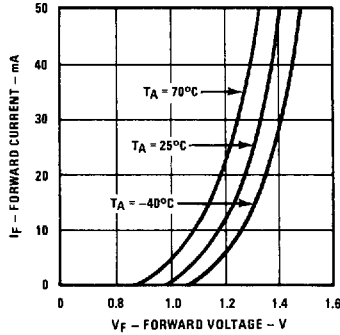

**Dark Current vs Free Air Temperature**

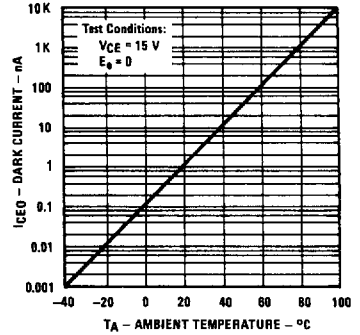

**Relative Output Current vs Free Air Temperature**

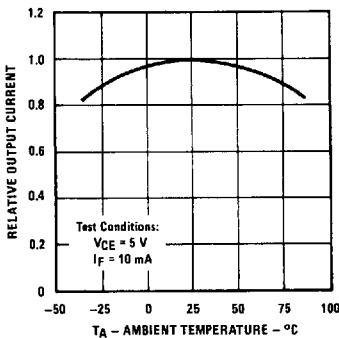

**Normalized Collector Current vs Angular Displacement**

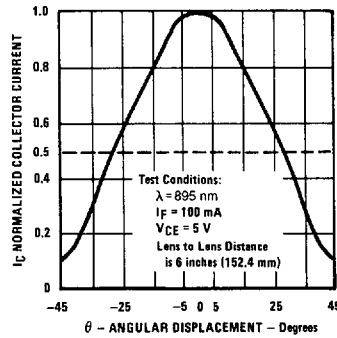

**Relative Power Output vs Forward Current (LED)**

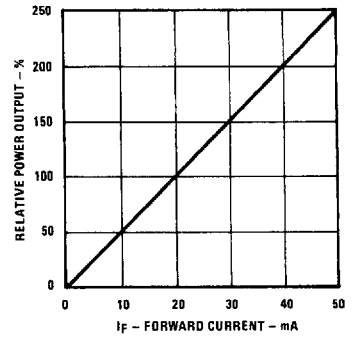

6798580 0002704 T34

Optek reserves the right to make changes at any time in order to improve design and to supply the best product possible.  
Optek Technology, Inc. 1215 W. Crosby Road Carrollton, Texas 75006 (972)323-2200 Fax (972)323-2396

MATCHED PAIRS