

Combo D® – Coaxial/50 Ohm

Right Angle Plug for PCB Mounting (Board Thickness Up to .125 [3.18])

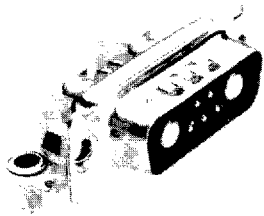

PCB Layouts – Pages 32-33.

Part numbers come complete with fixed, female, signal and coaxial contacts and right angle brackets.

Tin PC tails, add – A220.

D Size Connectors are mounted upside down (see diagram on page 33)

Contact Finish Compliant Boardlock	Gold Over Ni No	Gold Over Ni Yes	30 μ in. Gold No	30 μ in. Gold Yes
DE-5W1	DEMP5X1PJK87	DEMC5X1PJK87	DEMP5X1PJK127	DEMC5X1PJK127
DA-7W2	DAMP7X2PJK87	DAMC7X2PJK87	DAMP7X2PJK127	DAMC7X2PJK127
DA-11W1	DAMP11X1PJK87	DAMC11X1PJK87	DAMP11X1PJK127	DAMC11X1PJK127
DA-3W3	DAMP3X3PJK87	DAMC3X3PJK87	DAMP3X3PJK127	DAMC3X3PJK127
DB-5W5	DBMP5X5PJK87	DBMC5X5PJK87	DBMP5X5PJK127	DBMC5X5PJK127
DB-9W4	DBMP9X4PJK87	DBMC9X4PJK87	DBMP9X4PJK127	DBMC9X4PJK127
DB-13W3	DBMP13X3PJK87	DBMC13X3PJK87	DBMP13X3PJK127	DBMC13X3PJK127
DB-17W2	DBMP17X2PJK87	DBMC17X2PJK87	DBMP17X2PJK127	DBMC17X2PJK127
DB-21W1	DBMP21X1PJK87	DBMC21X1PJK87	DBMP21X1PJK127	DBMC21X1PJK127
DC-8W8	DCMP8X8PJK87	DCMC8X8PJK87	DCMP8X8PJK127	DCMC8X8PJK127
DC-13W6	DCMP13X6PJK87	DCMC13X6PJK87	DCMP13X6PJK127	DCMC13X6PJK127
DC-17W5	DCMP17X5PJK87	DCMC17X5PJK87	DCMP17X5PJK127	DCMC17X5PJK127
DC-21W4	DCMP21XA4PJK87	DCMC21XA4PJK87	DCMP21XA4PJK127	DCMC21XA4PJK127
DC-25W3	DCMP25X3PJK87	DCMC25X3PJK87	DCMP25X3PJK127	DCMC25X3PJK127
DC-27W2	DCMP27X2PJK87	DCMC27X2PJK87	DCMP27X2PJK127	DCMC27X2PJK127
DD-24W7	DDMP24X7PJK87	DDMC24X7PJK87	DDMP24X7PJK127	DDMC24X7PJK127
DD-36W4	DDMP36X4PJK87	DDMC36X4PJK87	DDMP36X4PJK127	DDMC36X4PJK127
DD-43W2	DDMP43X2PJK87	DDMC43X2PJK87	DDMP43X2PJK127	DDMC43X2PJK127
DD-47W1	DDMP47X1PJK87	DDMC47X1PJK87	DDMP47X1PJK127	DDMC47X1PJK127

Highlighted part numbers indicate standard product; usually available with shorter lead times.

Dimensions

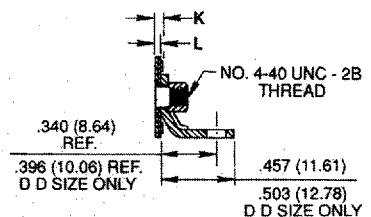
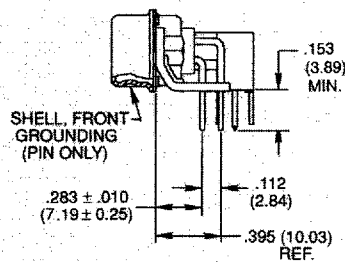
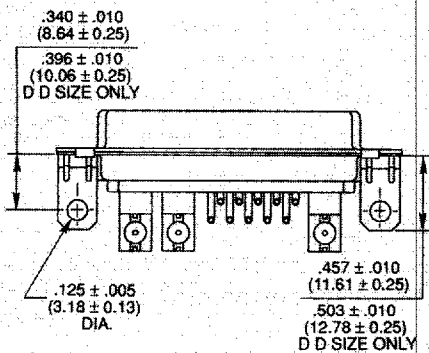
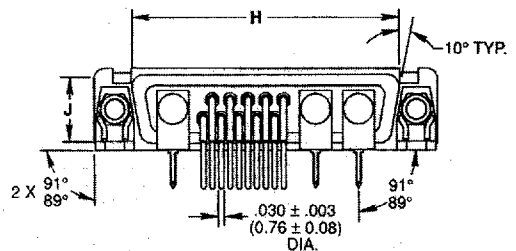
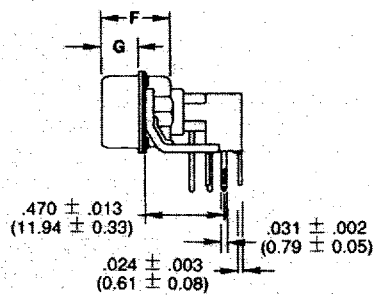
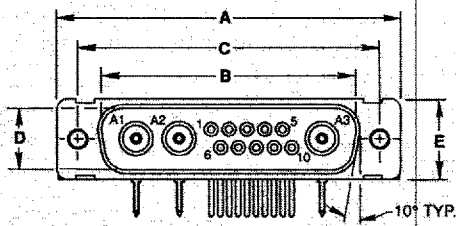

Plug Connector Assembly (Male)

Shell Size	A ±.015 (0.38)	B ±.010 (0.25)	C ±.005 (0.13)	D ±.010 (0.25)	E ±.015 (0.38)	F Max.	G ±.010 (0.25)	H Max.	J ±.010 (0.25)	K Max.	L ±.010 (0.25)
DE	1.213 (30.81)	.666 (16.91)	.984 (24.99)	.329 (8.36)	.494 (12.55)	.422 (10.72)	.236 (5.99)	.759 (19.28)	.430 (10.79)	.075 (1.90)	.032 (0.81)
DA	1.541 (39.14)	.994 (25.24)	1.312 (33.32)	.329 (8.36)	.494 (12.55)	.422 (10.72)	.236 (5.99)	1.083 (27.51)	.430 (10.79)	.075 (1.90)	.032 (0.81)
DB	2.088 (53.03)	1.534 (38.96)	1.852 (47.04)	.329 (8.36)	.494 (12.55)	.426 (10.82)	.231 (5.87)	1.625 (41.27)	.430 (10.79)	.075 (1.90)	.036 (0.91)
DC	2.729 (69.31)	2.182 (55.42)	2.500 (63.50)	.329 (8.36)	.494 (12.55)	.426 (10.82)	.231 (5.87)	2.272 (57.71)	.430 (10.79)	.075 (1.90)	.036 (0.91)
DD	2.635 (66.93)	2.079 (52.81)	2.406 (61.11)	.441 (11.20)	.605 (15.37)	.426 (10.82)	.231 (5.87)	2.178 (55.32)	.542 (13.77)	.075 (1.90)	.036 (0.91)



For technical assistance, price or delivery information, call your local technical sales office or distributor.

Dimensions are shown in inches (millimeters).
Dimensions subject to change.

Combination D Subminiature connectors are the fastest growing segment of the D Subminiature market. ITT Cannon engineering teams, in keeping pace with the demands of the industry, have developed the broadest selection of Combination D Subminiatures available.

We offer the ability to integrate signal and 50 and 75 ohm coax, high power, and high voltage. You can mix red, green, and blue video lines with signal and up to 40 amps of power in the same package.

Design variations of the new Combo D connector, versus other packaging methods, include the proven ITT Cannon polarized "D" shape to prevent mismatching; dense, space-saving packaging; and diverse mounting options. Choose from a variety of cable and printed wiring board selections. Printed wiring board combos come pre-assembled with fixed contacts eliminating the need to buy several components.

This new line of connectors offers you **unlimited design versatility**.

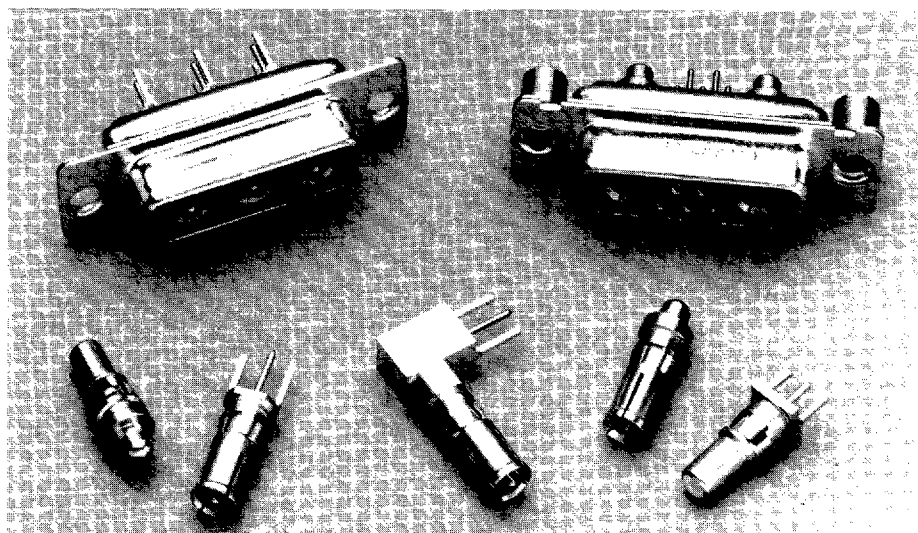

Straight and right angle printed wiring board contacts are available in both coax and high power versions.

Performance and Material Specifications

Connector Assemblies

Description	Material	Finish
Shell	Steel	Tin
Insulator	Thermoplastic or Diallyl Phthalate, UL 94V-0 rated.	None
Size 20 contacts when applicable	Copper alloy	Gold over nickel or 30μ inches, gold over nickel.
Standoff	Copper alloy	Electrodeposited Tin/Lead over Copper
Bracket	Steel	
Rivnut	Steel or Copper alloy	Electrodeposited Tin/Lead over Copper.
Eyelet	Copper alloy	

Coaxial Assembly

Contacts and shells	Copper alloy	Gold over nickel or 50μ inches gold over copper.
Ring, retaining	Copper alloy	Nickel
Insulator	Teflon	None

U.L. File Number: E8572

Performance Data

Signal Contact Current Rating	5 Amp
Temperature Rating	-65°C to +150°C
Signal Contact Resistance millivolt max.	55 @ 7.5 Amp test current
Coax Impedance	75 or 50 ohm
Coax VSWR	Less than 1.3-1.0 up to 500 megahertz
Coax Insertion Loss	.1 db loss at 500 megahertz.

Dielectric Withstanding Voltage

Type of Contact	Altitude (feet/m)								
	Sea Level		20,000/6096		50,000/15240		70,000/1336		
	90°	Straight	90°	Straight	90°	Straight	90°	Straight	
Center Conductor to Coaxial Shell	Average Flashover	1200	1500	900	1000	600	700	400	500
	Test	800	1000	600	650	400	475	275	325
Coaxial Shell to Nearest Standard Solder Pot Contact	Average Flashover	•	1500	•	1500	•	900	•	650
	Test	•	1000	•	1000	•	600	•	425
High Power contact and/or Coaxial Shell to Plug Shell	Average Flashover	1500	1500	1000	1000	500	500	500	500
	Test	1000	1000	650	650	325	325	325	325
#20 Signal	Average Flashover	1700		1000		650		500	
	Test	1250		750		475		375	
HV Contact to Nearest Contact or to Shell	Average Flashover	3800	3800	2300	2300	900	900	650	650
	Test	2800	2800	1700	1700	675	675	475	475

All voltage figures are rms AC 60 rms cps, measured at approximately +25°C, 50% rh.

Impedance: 50 ohm, 75 ohm

Right Angle Printed Circuit Board Hole Pattern

Face view, pin insert
(for receptacle, hole pattern is a mirror image)

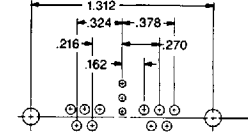
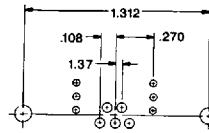
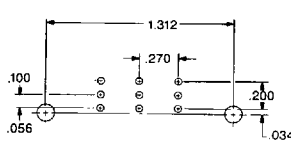
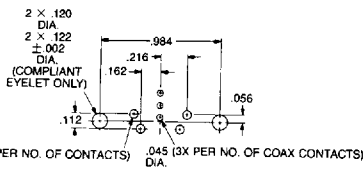

Shell Size **E**
Contact Arrangement **5W1**
No. of Signal Contacts **4 #20**
No. of Coaxial Contacts **1**

Shell Size **A**
Contact Arrangement **3W3**
No. of Signal Contacts **0**
No. of Coaxial Contacts **3**

Shell Size **A**
Contact Arrangement **7W2**
No. of Signal Contacts **5 #20**
No. of Coaxial Contacts **2**

Shell Size **A**
Contact Arrangement **11W1**
No. of Signal Contacts **10 #20**
No. of Coaxial Contacts **1**

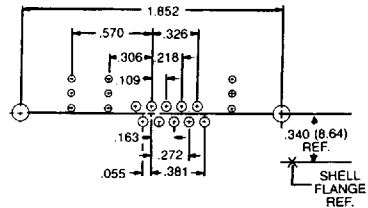
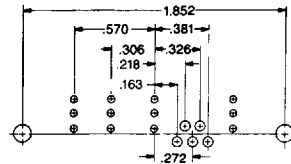
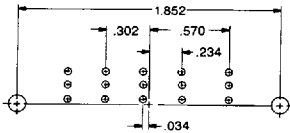

Shell Size **B**
Contact Arrangement **5W5**
No. of Signal Contacts **0**
No. of Coaxial Contacts **5**

Shell Size **B**
Contact Arrangement **9W4**
No. of Signal Contacts **5 #20**
No. of Coaxial Contacts **4**

Shell Size **B**
Contact Arrangement **13W3**
No. of Signal Contacts **10 #20**
No. of Coaxial Contacts **3**

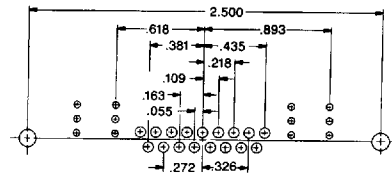
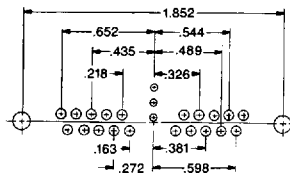
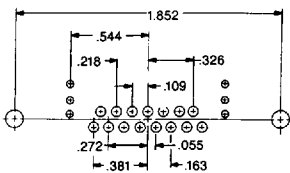

Shell Size **B**
Contact Arrangement **17W2**
No. of Signal Contacts **15 #20**
No. of Coaxial Contacts **2**

Shell Size **B**
Contact Arrangement **21W1**
No. of Signal Contacts **20 #20**
No. of Coaxial Contacts **1**

Shell Size **C**
Contact Arrangement **21WA4**
No. of Signal Contacts **17 #20**
No. of Coaxial Contacts **4**

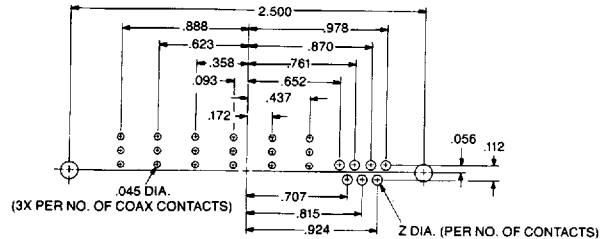
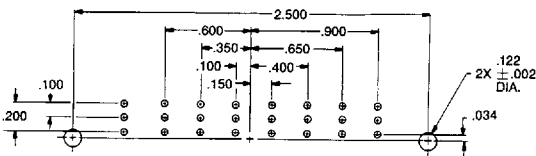

Shell Size **C**
Contact Arrangement **8W8**
No. of Signal Contacts **0**
No. of Coaxial Contacts **8**

Shell Size **C**
Contact Arrangement **13W6**
No. of Signal Contacts **7 #20**
No. of Coaxial Contacts **6**

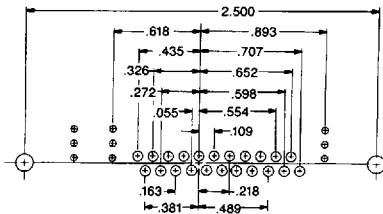
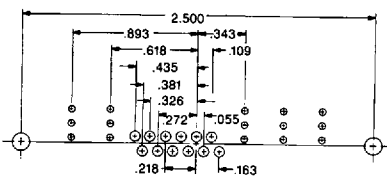

Shell Size **C**
Contact Arrangement **17W5**
No. of Signal Contacts **12 #20**
No. of Coaxial Contacts **5**

Shell Size **C**
Contact Arrangement **25W3**
No. of Signal Contacts **22 #20**
No. of Coaxial Contacts **3**

Size #20 Contact PC Tail Dia.	Z Dia.
.030 (0.76)	.045 (1.14)

Combo D[®] - Coaxial

Right Angle Printed Circuit Board Hole Patterns

Face view, pin insert
(for receptacle, hole pattern is a mirror image)

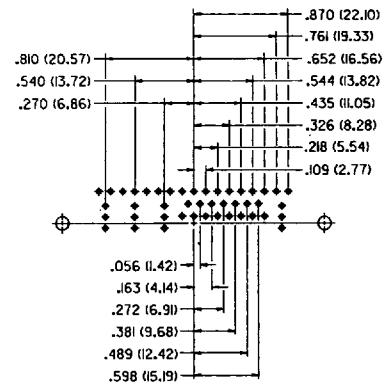
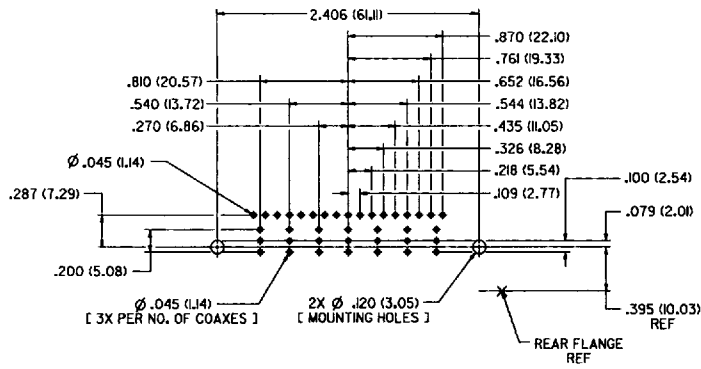

Shell Size
Contact Arrangement
No. of Signal Contacts
No. of Coaxial Contacts

D
24W7
17 #20
7

D
36W4
32 #20
4

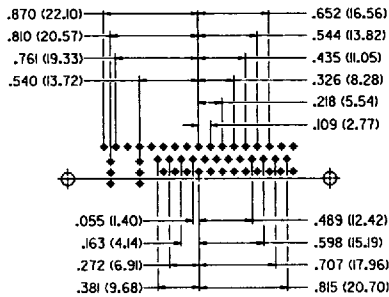

Shell Size
Contact Arrangement
No. of Signal Contacts
No. of Coaxial Contacts

D
43W2
41 #20
2

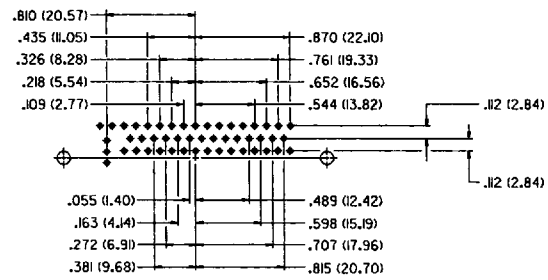

D
47W1
46 #20
1

Right Angle Coax Layouts - D Size

NOTE: Mounting is upside down.

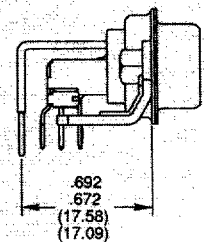
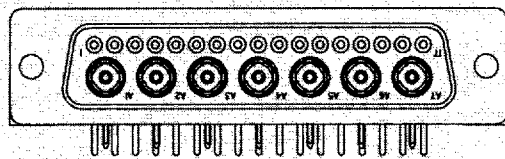

ITT Cannon

For technical assistance, price or delivery information, call your local technical sales office or distributor.

Dimensions are shown in inches (millimeters).
Dimensions subject to change.

Coaxial Housing With Solder Cup Signal Contacts

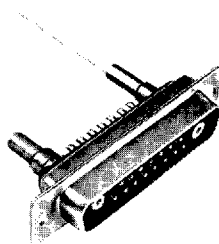

- Cable combinations supplied with preloaded solder signal contacts
- 50 ohm coax contacts supplied separately (see pages 27-28)
- 75 ohm coax contacts supplied separately (see page 23)

Clinch Nut and Float Mount Options Available:

Add: E = 4-40 Clinch Nut

Y = Float Mounting

Example: DAME3W3PK87

DAMY3W3PK87

Mounting Method Detail – Page 6.

Layout	Standard Socket	30 μ in. Gold Socket	Standard Pin	30 μ in. Gold Pin
DE-5W1	DEM5W1SA197	DEM5W1SK126	DEM5W1PK87	DEM5W1PK127
DA-7W2	DAM7W2SA197	DAM7W2SK126	DAM7W2PK87	DAM7W2PK127
DA-11W1	DAM11W1SA197	DAM11W1SK126	DAM11W1PK87	DAM11W1PK127
DA-3W3	DAM3W3SA197	DAM3W3SK126	DAM3W3PK87	DAM3W3PK127
DB-5W5	DBM5W5SA197	DBM5W5SK126	DBM5W5PK87	DBM5W5PK127
DB-9W4	DBM9W4SA197	DBM9W4SK126	DBM9W4PK87	DBM9W4PK127
DB-13W3	DBM13W3SA197	DBM13W3SK126	DBM13W3PK87	DBM13W3PK127
DB-17W2	DBM17W2SA197	DBM17W2SK126	DBM17W2PK87	DBM17W2PK127
DB-21W1	DBM21W1SA197	DBM21W1SK126	DBM21W1PK87	DBM21W1PK127
DC-8W8	DCM8W8SA197	DCM8W8SK126	DCM8W8PK87	DCM8W8PK127
DC-13W6	DCM13W6SA197	DCM13W6SK126	DCM13W6PK87	DCM13W6PK127
DC-17W5	DCM17W5SA197	DCM17W5SK126	DCM17W5PK87	DCM17W5PK127
DC-21WA4	DCM21WA4SA197	DCM21WA4SK126	DCM21WA4PK87	DCM21WA4PK127
DC-25W3	DCM25W3SA197	DCM25W3SK126	DCM25W3PK87	DCM25W3PK127
DC-27W2	DCM27W2SA197	DCM27W2SK126	DCM27W2PK87	DCM27W2PK127
DD-24W7	DDM24W7SA197	DDM24W7SK126	DDM24W7PK87	DDM24W7PK127
DD-36W4	DDM36W4SA197	DDM36W4SK126	DDM36W4PK87	DDM36W4PK127
DD-43W2	DDM43W2SA197	DDM43W2SK126	DDM43W2PK87	DDM43W2PK127
DD-47W1	DDM47W1SA197	DDM47W1SK126	DDM47W1PK87	DDM47W1PK127

Highlighted part numbers indicate standard product; usually available with shorter lead times.

Contact Arrangements

(Will accommodate Removable Coax, Power and/or High Voltage Contacts)

Note: Color Code — Pin Connector: Red, Socket Connector: Blue

Shell Size	E	A	A	A	B	B
Contact Arrangement	5W1	3W3	7W2	11W1	5W5	9W4
No. of Signal Contacts	4 #20	0	5 #20	10 #20	0	5 #20
No. of Coaxial Contacts	1	3	2	1	5	4
Shell Size	B	B	B	B	C	C
Contact Arrangement	13W3	17W2	21W1	8W8		
No. of Signal Contacts	10 #20	15 #20	20 #20	0		
No. of Coaxial Contacts	3	2	1	8		
Shell Size	C	C	C	C	C	C
Contact Arrangement	13W6	17W5	21WA4	25W3		
No. of Signal Contacts	7 #20	12 #20	17 #20	22 #20		
No. of Coaxial Contacts	6	5	4	3		
Shell Size	C	D	D	D	D	D
Contact Arrangement	27W2	36W4	43W2			
No. of Signal Contacts	25 #20	32 #20	41 #20			
No. of Coaxial Contacts	2	4	2			
Shell Size	D	D	D	D	D	D
Contact Arrangement	24W7	47W1				
No. of Signal Contacts	17 #20	46 #20				
No. of Coaxial Contacts	7	1				