

Alle Rechte vorbehalten/ All rights reserved

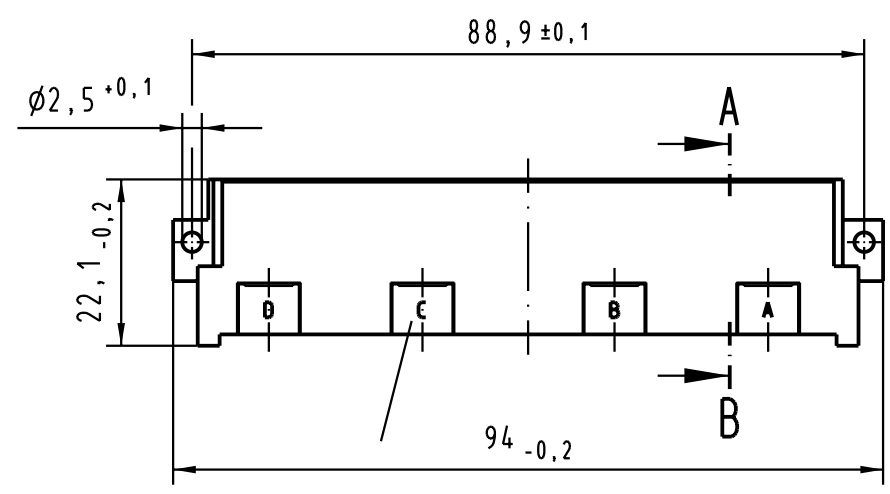

Sollbruchstelle für Kodierung
breaking point for coding

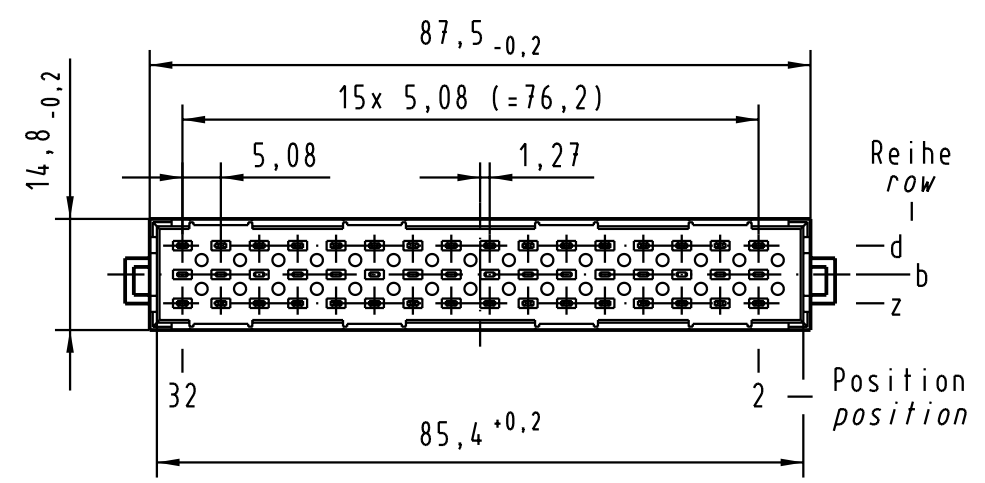
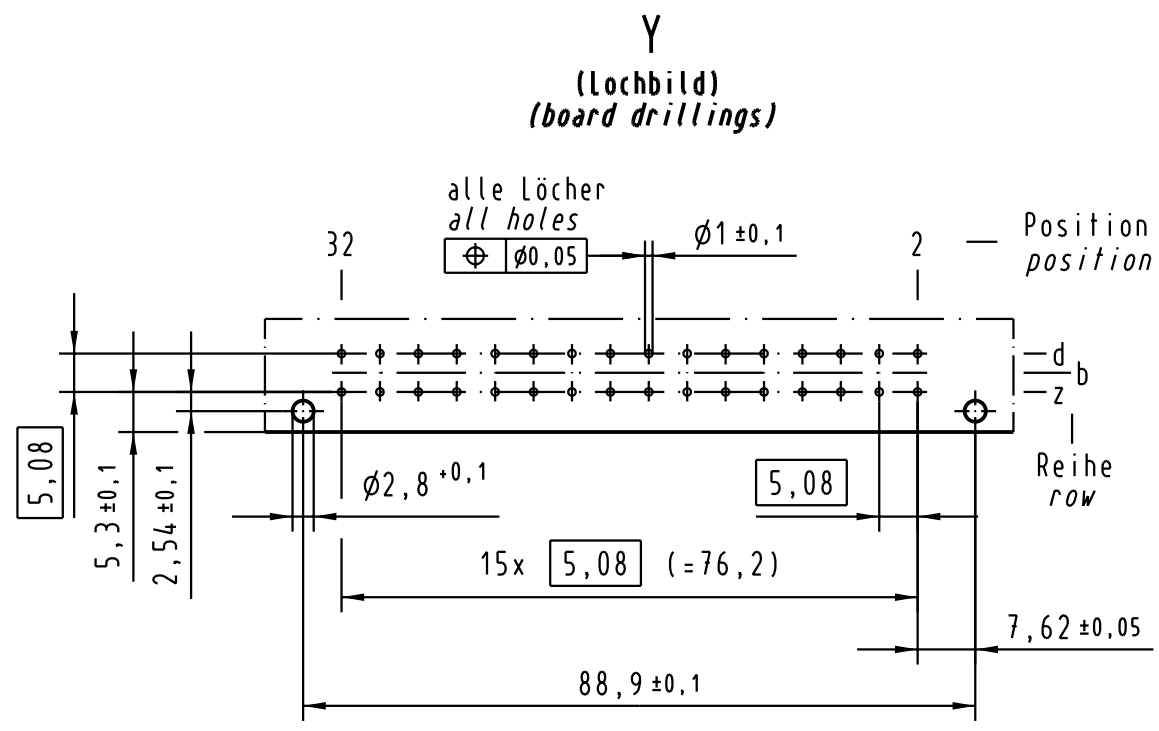
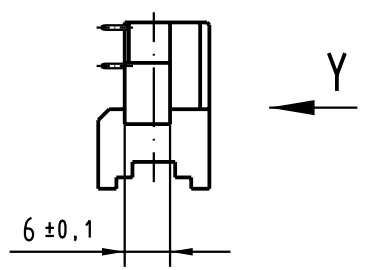
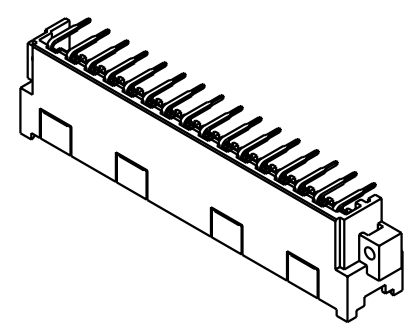
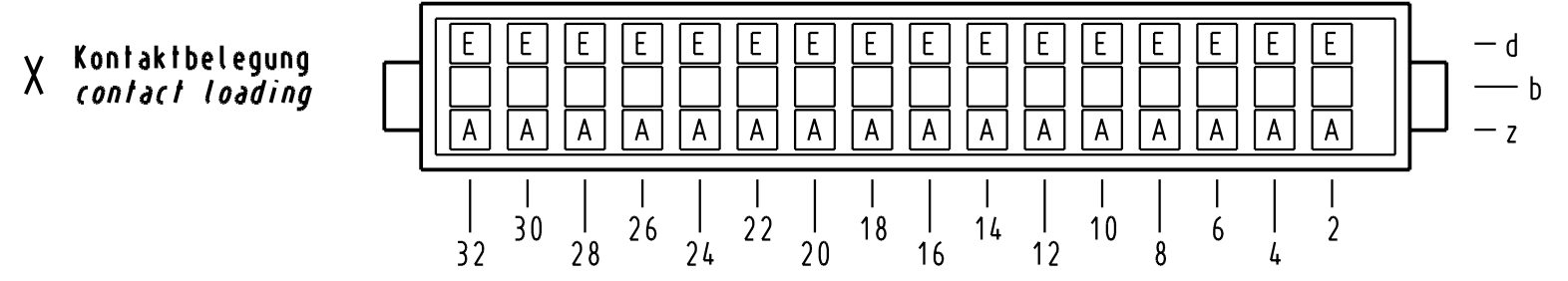
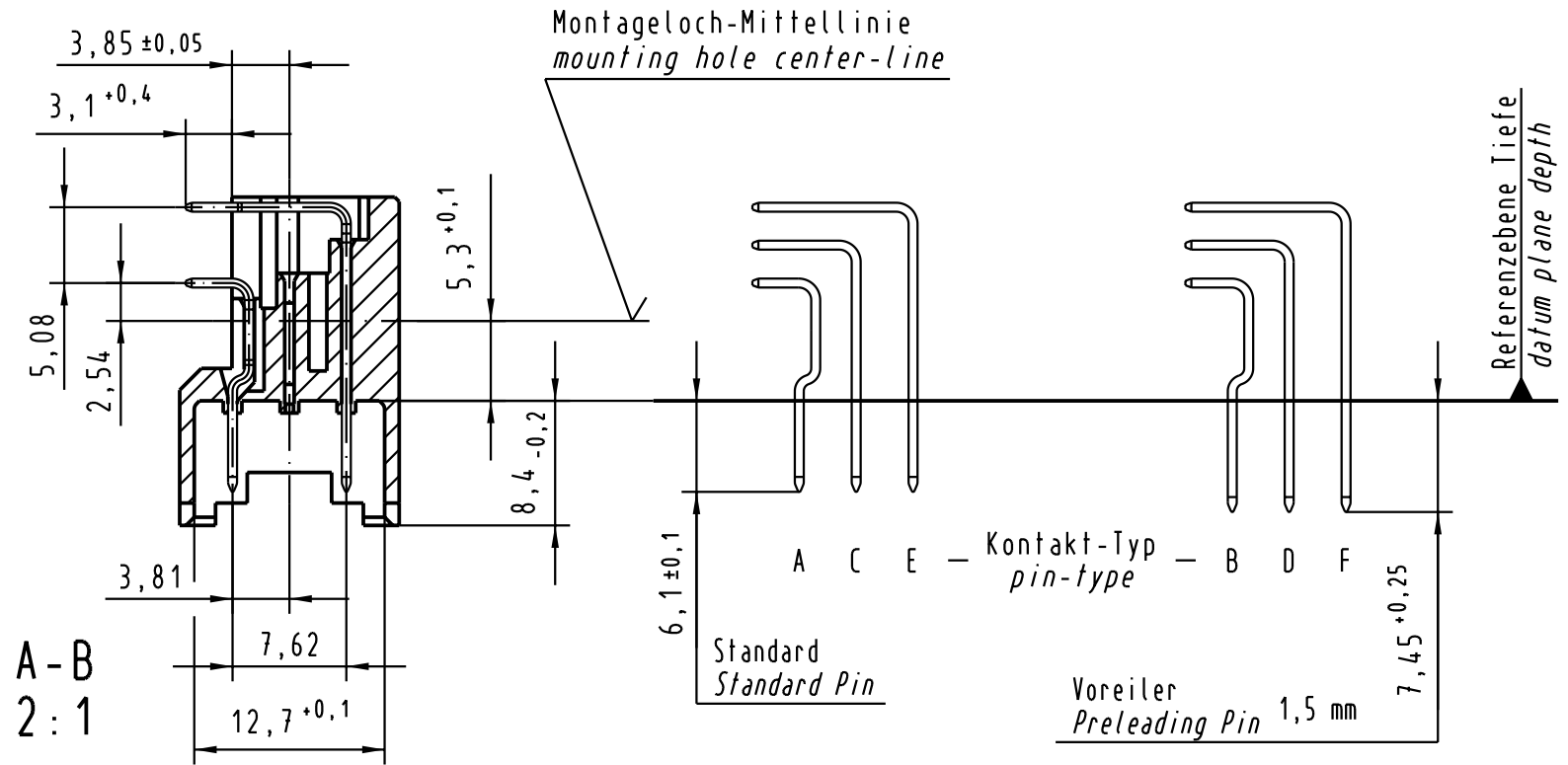

09 06 132 4931	VG	Au über/over Ni
09 06 132 7931	3	Au über/over Ni
09 06 132 6931	2	Au über/over Ni
09 06 132 2931	1	Au über/over Ni
Bestell-Nr. Part-No.	Anforderungsstufe nach IEC performance level per IEC	Kontaktoberfläche Contact Plating

30386 Mod.	Dat.	Name	Techn. Character.		Nicht tolerierte Maß/Free size tolerances siehe / see IEC 60603-2	
			Detail.	Dat.	Name	Maßstab/Scale 1:1 (2:1)
			Insp.	29.01.02	kfoe	
			Stand.			
HARTING Electronics GmbH & Co. KG D-32339 ESPELKAMP					TB 09 06 132 x931 Sub.	
						Blatt/ page